

UNIFIED FACILITIES CRITERIA (UFC)

DESIGN: AIRCRAFT FIXED POINT UTILITY SYSTEMS



APPROVED FOR PUBLIC RELEASE; DISTRIBUTION UNLIMITED

UNIFIED FACILITIES CRITERIA (UFC)

DESIGN: AIRCRAFT FIXED POINT UTILITY SYSTEMS

Any copyrighted material included in this UFC is identified at its point of use.
Use of the copyrighted material apart from this UFC must have the permission of the
copyright holder.

U.S. ARMY CORPS OF ENGINEERS

NAVAL FACILITIES ENGINEERING COMMAND (Preparing Activity)

AIR FORCE CIVIL ENGINEERING SUPPORT AGENCY

Record of Changes (changes indicated by \1\ ... /1/)

<u>Change No.</u>	<u>Date</u>	<u>Location</u>

FOREWORD

The Unified Facilities Criteria (UFC) system is prescribed by MIL-STD 3007 and provides planning, design, construction, sustainment, restoration, and modernization criteria, and applies to the Military Departments, the Defense Agencies, and the DoD Field Activities in accordance with [USD\(AT&L\) Memorandum](#) dated 29 May 2002. UFC will be used for all DoD projects and work for other customers where appropriate. All construction outside of the United States is also governed by Status of forces Agreements (SOFA), Host Nation Funded Construction Agreements (HNFA), and in some instances, Bilateral Infrastructure Agreements (BIA.) Therefore, the acquisition team must ensure compliance with the more stringent of the UFC, the SOFA, the HNFA, and the BIA, as applicable.

UFC are living documents and will be periodically reviewed, updated, and made available to users as part of the Services' responsibility for providing technical criteria for military construction. Headquarters, U.S. Army Corps of Engineers (HQUSACE), Naval Facilities Engineering Command (NAVFAC), and Air Force Civil Engineer Support Agency (AFCESA) are responsible for administration of the UFC system. Defense agencies should contact the preparing service for document interpretation and improvements. Technical content of UFC is the responsibility of the cognizant DoD working group. Recommended changes with supporting rationale should be sent to the respective service proponent office by the following electronic form: [Criteria Change Request \(CCR\)](#). The form is also accessible from the Internet sites listed below.

UFC are effective upon issuance and are distributed only in electronic media from the following source:

- Whole Building Design Guide web site <http://dod.wbdg.org/>.

Hard copies of UFC printed from electronic media should be checked against the current electronic version prior to use to ensure that they are current.

AUTHORIZED BY:



DONALD L. BASHAM, P.E.
Chief, Engineering and Construction
U.S. Army Corps of Engineers



DR. JAMES W. WRIGHT, P.E.
Chief Engineer
Naval Facilities Engineering Command

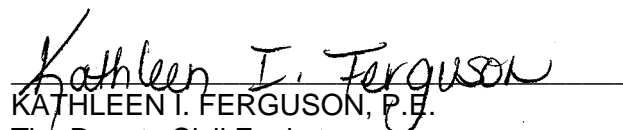

KATHLEEN I. FERGUSON, P.E.
The Deputy Civil Engineer
DCS/Installations & Logistics
Department of the Air Force

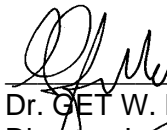

Dr. GET W. MOY, P.E.
Director, Installations Requirements and
Management
Office of the Deputy Under Secretary of Defense
(Installations and Environment)

CONTENTS

	Page
CHAPTER 1 INTRODUCTION	
Paragraph 1-1 PURPOSE AND SCOPE	1-1
1-2 APPLICABILITY	1-1
1-2.1 General Building Requirements	1-1
1-2.2 Safety	1-1
1-2.3 Fire Protection	1-1
1-2.4 Antiterrorism/Force Protection	1-1
1-3 REFERENCES	1-1
APPENDIX A MIL-HDBK 1028/6A.....	A-1

CHAPTER 1

INTRODUCTION

1-1 **PURPOSE AND SCOPE.** This UFC is comprised of two sections. Chapter 1 introduces this UFC and provides a listing of references to other Tri-Service documents closely related to the subject. Appendix A contains the full text copy of the previously released Military Handbook (MIL-HDBK) on this subject. This UFC serves as criteria until such time as the full text UFC is developed from the MIL-HDBK and other sources.

This UFC provides general criteria for the design of aircraft fixed point utility systems.

Note that this document does not constitute a detailed technical design, maintenance or operations manual, and is issued as a general guide to the considerations associated with the design of aircraft fixed point utility systems.

1-2 **APPLICABILITY.** This UFC applies to all Navy service elements and Navy contractors; Army service elements should use the references cited in paragraph 1-3 below; all other DoD agencies may use either document unless explicitly directed otherwise.

1-2.1 **GENERAL BUILDING REQUIREMENTS.** All DoD facilities must comply with UFC 1-200-01, *Design: General Building Requirements*. If any conflict occurs between this UFC and UFC 1-200-01, the requirements of UFC 1-200-01 take precedence.

1-2.2 **SAFETY.** All DoD facilities must comply with DODINST 6055.1 and applicable Occupational Safety and Health Administration (OSHA) safety and health standards.

NOTE: All **NAVY** projects, must comply with OPNAVINST 5100.23 (series), *Navy Occupational Safety and Health Program Manual*. The most recent publication in this series can be accessed at the NAVFAC Safety web site: www.navfac.navy.mil/safety/pub.htm. If any conflict occurs between this UFC and OPNAVINST 5100.23, the requirements of OPNAVINST 5100.23 take precedence.

1-2.3 **FIRE PROTECTION.** All DoD facilities must comply with UFC 3-600-01, *Design: Fire Protection Engineering for Facilities*. If any conflict occurs between this UFC and UFC 3-600-01, the requirements of UFC 3-600-01 take precedence.

1-2.4 **ANTITERRORISM/FORCE PROTECTION.** All DoD facilities must comply with UFC 4-010-01, *Design: DoD Minimum Antiterrorism Standards for Buildings*. If any conflict occurs between this UFC and UFC 4-010-01, the requirements of UFC 4-010-01 take precedence.

1-3 **REFERENCES.** The following Tri-Service publications have valuable information on the subject of this UFC. When the full text UFC is developed for this

subject, applicable portions of these documents will be incorporated into the text. The designer is encouraged to access and review these documents as well as the references cited in Appendix A.

1. US Army Corps of Engineers
Commander
USACE Publication Depot
ATTN: CEIM-IM-PD
2803 52nd Avenue
Hyattsville, MD 20781-1102
(301) 394-0081 fax: 0084
karl.abt@hq02.usace.army.mil
<http://www.usace.army.mil/inet/usace-docs/>
- USACE TL 1110-3-430**, Design of U.S.
Army Airfield Aircraft Mooring and
Grounding Points for Rotary Wing
Aircraft, 23 September 1991

APPENDIX A

**MIL-HDBK 1028/6A
AIRCRAFT FIXED POINT UTILITY SYSTEMS**

INCH-POUND

MIL-HDBK-1028/6
31 MAY 1996

SUPERSEDING
MIL-HDBK-1028/6
30 SEPTEMBER 1988

MILITARY HANDBOOK

AIRCRAFT FIXED POINT UTILITY SYSTEMS



AMSC N/A

AREA FACR

DISTRIBUTION STATEMENT A. APPROVED FOR PUBLIC RELEASE: DISTRIBUTION IS UNLIMITED.

ABSTRACT

This handbook provides basic design guidance for aircraft ground power facilities Category Code 149-15. It has been developed from extensive re-evaluation of facilities and is intended for use by experienced architects and engineers. The contents include preliminary design data for the central utilities supply, distribution, and aircraft ground power fixed point (permanently located) service areas. Specific data are given for engine starting air, environmental control system cooling air, preconditioned cooling air for hangar aircraft, compressed air for maintenance operations, 400 Hz and 60 Hz electrical power distribution systems.

FOREWORD

This handbook has been developed from an evaluation of facilities in the shore establishment, from surveys of the availability of new materials and construction methods, and from selection of the best design practices of the Naval Facilities Engineering Command (NAVFACENGCOM), other Government agencies, and the private sector. This handbook was prepared using, to the maximum extent feasible, national professional society, association, and institute standards. Deviations from this criteria, in the planning, engineering, design, and construction of Naval shore facilities, cannot be made without prior approval of NAVFACENGCOM Criteria Office, Code 15C.

Design cannot remain static any more than can the functions it serves or the technologies it uses. Accordingly, recommendations for improvement are encouraged and should be furnished to Commanding Officer, Southern Division,, Naval Facilities Engineering Command, Code 0741, P.O. Box 190010, North Charleston, SC 29419-9010; telephone (803) 820-7404.

THIS HANDBOOK SHALL NOT BE USED AS A REFERENCE DOCUMENT FOR PROCUREMENT OF FACILITIES CONSTRUCTION. IT IS TO BE USED IN THE PURCHASE OF FACILITIES ENGINEERING STUDIES AND DESIGN (FINAL PLANS, SPECIFICATIONS, AND COST ESTIMATES). DO NOT REFERENCE IT IN MILITARY OR FEDERAL SPECIFICATIONS OR OTHER PROCUREMENT DOCUMENTS.

MAINTENANCE FACILITIES CRITERIA MANUALS

<u>Criteria Manual</u>	<u>Title</u>	<u>PA</u>
MIL-HDBK-1028/1	Aircraft Maintenance Facilities	LANTDIV
MIL-HDBK-1028/3	Maintenance Facilities for Ammunition, Explosives, and Toxins	LANTDIV
DM-28.04	General Maintenance Facilities	WESTDIV
MIL-HDBK-1028/5	Environmental Control - Design of Clean Rooms	LANTDIV
MIL-HDBK-1028/6	Aircraft Fixed Point Utility Systems	SOUTHDIV
MIL-HDBK-1028/8	Pest Control Facilities	NAVFAC

NOTE: Design manuals, when revised, will be converted to military handbooks.

AIRCRAFT FIXED POINT UTILITY SYSTEMS

CONTENTS

		<u>Page</u>
Section 1	INTRODUCTION	
1.1	Scope.....	1
1.2	Cancellation.....	1
Section 2	FIXED POINT UTILITY SYSTEMS	
2.1	General.....	2
2.1.1	Planning.....	2
2.1.2	Aircraft Services.....	2
2.1.2.1	Alternate 1.....	2
2.1.2.2	Alternate 2.....	2
2.1.3	Central Equipment Facilities.....	3
2.1.4	Utilities Distribution.....	3
2.1.5	Site Configuration.....	3
2.2	Utility System Load Determinations.....	4
2.2.1	Aircraft Utility Demands.....	4
2.2.2	System Load Diversity.....	4
2.2.3	System Load Demands.....	4
2.3	Starting Air System.....	4
2.3.1	System Components.....	8
2.3.2	Design Requirements.....	8
2.3.3	Design Conditions.....	8
2.4	Environmental Control System (ECS).....	8
2.4.1	System Components.....	8
2.4.2	Design Requirements.....	9
2.4.3	Design Conditions.....	9
2.5	Preconditioned Cooling Air System.....	9
2.6	Electrical System.....	9
2.6.1	System Components.....	9
2.6.2	Design Requirements.....	10
Section 3	SYSTEM COMPONENT SELECTION	
3.1	Standardization of Components.....	26
3.1.1	Minimum Unit Demands.....	26
3.1.2	Maximum Unit Capacities.....	26
3.1.3	Design Methods.....	26
3.1.4	Design Method Summaries.....	26
3.1.4.1	Selecting Starting Air Equipment.....	26
3.1.4.2	Selecting ECS Air Equipment.....	27
3.2	Starting Air System.....	27
3.2.1	Air Compressor and Auxiliaries.....	27
3.2.1.1	Compressor.....	27
3.2.1.2	Intercooler.....	34
3.2.1.3	Motor.....	34

		<u>Page</u>
3.2.1.4	Air Intake Filter Silencer.....	34
3.2.1.5	Aftercooler.....	34
3.2.1.6	Aftercooler (Alternate).....	34
3.2.1.7	Oil Separator.....	34
3.2.1.8	Refrigerated Air Dryer.....	34
3.2.1.9	Cooling Water Assembly (for Water-Cooled Aftercooler).....	34
3.2.1.10	Circulating Pumps.....	34
3.2.1.11	Controls.....	34
3.2.2	Air Receiver Storage Tanks.....	34
3.2.3	Miscellaneous Equipment and Piping.....	35
3.2.3.1	Distribution System Pressure Control Valve.....	35
3.2.3.2	Pressure Relief Valve.....	35
3.2.3.3	Piping.....	35
3.2.3.4	Miscellaneous Equipment.....	35
3.2.4	Distribution System.....	35
3.3	Environmental Control Cooling Air System..	35
3.3.1	Air Compressor and Auxiliaries.....	36
3.3.1.1	Compressor.....	36
3.3.1.2	Intercoolers and Aftercooler.....	36
3.3.1.3	Drive Motor.....	36
3.3.1.4	Air Intake Filter-Silencer.....	36
3.3.1.5	Oil Separator.....	36
3.3.1.6	Refrigerated Air Dryer.....	36
3.3.1.7	Cooling Water Assembly (Evaporative Type)..	36
3.3.1.8	Alternate Cooling Water Assembly.....	36
3.3.1.9	Circulating Pumps.....	37
3.3.1.10	Controls.....	37
3.3.2	Miscellaneous Equipment and Piping.....	37
3.3.3	Distribution System.....	37
3.4	60-Hz Electrical System.....	38
3.4.1	Switchgear and Equipment.....	38
3.4.1.1	Switchgear Assembly.....	38
3.4.2	Distribution System.....	38
3.4.2.1	Main Feeders.....	38
3.4.3	Aircraft Grounding Point Requirements.....	38
3.5	400 Hz Electrical System.....	38

Section 4

CENTRAL FACILITIES BUILDING

4.1	General.....	39
4.2	Building.....	39
4.2.1	Restrictions on the Use of Aluminum.....	39
4.2.2	Architectural Requirements.....	39
4.2.2.1	Walls.....	39
4.2.2.2	Roof.....	39
4.2.2.3	Floors.....	39

		<u>Page</u>
4.2.2.4	Entrances.....	40
4.2.2.5	Rooms.....	40
4.2.2.6	Floor Trenches.....	40
4.2.3	Structural Requirements.....	40
4.2.3.1	Foundations.....	40
4.2.3.2	Building Frame.....	40
4.2.3.3	Floor Structures.....	40
4.2.3.4	Equipment Pads.....	40
4.2.4	Mechanical Requirements.....	40
4.2.4.1	Plumbing System.....	41
4.2.4.2	Heating System.....	41
4.2.4.3	Ventilation System.....	41
4.2.5	Electrical Requirements.....	41
4.2.5.1	Lighting.....	41
4.2.5.2	Communications.....	41
Section 5	FEEDER DISTRIBUTION CENTERS	
5.1	Electrical Distribution.....	42
Section 6	UNDERGROUND INSTALLATIONS	
6.1	Mains and Feeders.....	43
6.1.1	Compressed Air Piping.....	43
6.1.2	Electrical.....	43
6.1.2	Service Access Points.....	43
6.2.1	Valve Boxes.....	43
Section 7	AIRCRAFT SERVICE POINTS	
7.1	Parking Apron Service Points.....	44
7.1.1	Construction.....	44
7.1.2	Mechanical Equipment Components.....	44
7.1.3	Electrical Equipment Components.....	45
7.1.3.1	60 Hz Components.....	45
7.1.3.2	400 Hz Components.....	46
Section 8	HANGAR SERVICE POINTS	
8.1	Hangar Service Points.....	47
8.1.1	Construction	47
8.1.2	Compressed Air Equipment Components.....	47
8.1.3	Preconditioned Air Equipment Components...	47
8.1.4	Preconditioned Air Equipment Components (Alternate).....	48
8.1.5	Electrical System Components.....	48
8.1.5.1	60 Hz Components.....	48
8.1.5.2	400 Hz Components.....	49

APPENDIX

APPENDIX A	Metric Equivalent Chart.....	50
------------	------------------------------	----

FIGURES

Figure 1	Typical FPUS Site Plan.....	7
2	FPUS Diversity Curve.....	11
3	Starting Air System.....	12
4	ECS Air System.....	13
5	Preconditioned Cooling Air System (Under Development).....	14
6	Typical One Line Diagram Central Facilities - ECS System.....	15
7	Typical One Line Diagram Central Facilities - Air Start System.....	16
8	Typical Parking Apron Service Point Electrical One-Line Diagram.....	17
9	Typical Hangar Service Point Electrical One-Line Diagram.....	18
10	Feeder Distribution Center.....	19
11	FPUS Electrical Symbols.....	20
12	FPUS Electrical Symbols.....	21
13	Aircraft Service Console Mechanical Schematic.....	22
14	Aircraft Service Mechanical Symbols.....	23

TABLES

Table 1	Summary of Aircraft Utility Demands.....	5
2	Summary of Design Method for Quantities and Ratings, Central Facilities Equipment Selection, Starting Air System.....	28
3	Summary of Design Method Starting Air System.....	29
4	Summary of Design Method for Quantities and Ratings, Central Facilities Equipment Selection, and Environmental Control Air System.....	30
5	Summary of Design Method, Environmental Control Air System.....	31

		<u>Page</u>
6	Summary of Design Method for Quantities and Ratings, Preconditioned Air Equipment Selection.....	32
7	Summary of Design Method, Preconditioned Air System.....	33
BIBLIOGRAPHY.....		53
REFERENCES.....		54
GLOSSARY.....		57

Section 1: INTRODUCTION

1.1 Scope. This handbook contains design criteria for ground power utilities service to naval aircraft at shore activities. Utilities included are engine starting air, environmental control system compressed air, hangar preconditioned air, apron and maintenance hangar utility air, 400 Hz and 60 Hz electrical power. The installations include central facilities supply, distribution systems and aircraft fixed point (permanently located) services.

1.2 Cancellation. This handbook, MIL-HDBK-1028/6A, dated 31 May 1996, cancels and supersedes MIL-HDBK-1028/6, dated 30 September 1988.

Section 2: FIXED POINT UTILITY SYSTEMS

2.1 General. Design of the fixed point utility system (FPUS) requires determining the number and type of aircraft to be served, ground support requirements of the particular aircraft, expected diversity of the aircraft loads and site configuration. Resolving these variables provides the central facilities utility demands, equipment capacities, line size and routing of the distribution system, and aircraft service point requirements.

2.1.1 Planning. The FPUS concept is based upon the economy of supply of aircraft utilities from a centralized plant of energy-efficient components. Include the following considerations in FPUS planning for a particular aircraft maintenance facility:

a) Orderly expansion of the system components to accommodate probable future hangar bays and parking apron service points.

b) Economic feasibility of supplying adjacent or nearby facilities (existing or future) from the centralized supply.

c) Relocatability of ground support equipment versus FPUS installed equipment.

d) Probability of function relocation or base closure.

2.1.2 Aircraft Services. Fixed point systems shall supply aircraft utilities at parking apron service points and maintenance hangar service points. The FPUS required are compressed air, preconditioned air for hangar aircraft, and electrical power. Two system design alternatives are feasible. (See Table 1 for a summary of aircraft utility demands.)

2.1.2.1 Alternate 1. The air start system provides compressed air at the parking apron service points. Aircraft cooling is provided by mobile ground carts. The selection of the air start system or environmental control system (ECS) system is based upon system requirements and economic factors. Factors affecting the system selection include central plant and utility distribution construction costs, local environmental conditions, and local utility rate structures. Manpower requirements, space limitations, system dependability, and air quality permits to operate fuel fired yellow gear equipment outdoors must be considered in addition to economic analysis. The air start system will generally have the lowest initial cost and shortest payback period while using the least energy of any current design option.

2.1.2.2 Alternate 2. The ECS, provides compressed air for engine starting air and ECS compressed air at the parking apron service points from a central source. The ECS will generally have the lowest operating

and maintenance costs, resulting in the highest overall life-cycle cost savings. The ECS system also has inherent operational advantages by requiring fewer operating personnel and minimizing the need for ground support equipment. The ECS requires no starting air recovery period. Dedicated and separate panels for the electrical and mechanical services shall be provided. For maintenance hangar service points, provide electrical and mechanical services as shown in Figures 9, 10, 11, and 12 in the later sections of this handbook. Separate dedicated panels for mechanical and electrical services shall be provided.

2.1.3 Central Equipment Facilities. The central facilities area shall provide the equipment building and yard area for compressed air storage tanks and substation type transformers, and switchgear for main electrical service. The building shall accommodate the air compressors and auxiliary equipment, electrical service, and distribution apparatus. The equipment for preconditioned air supply to hangar aircraft shall be located within a hangar equipment room, a penthouse of the shop area or a separate structure. Refer to MIL-HDBK-1004/5, 400-Hertz Medium-Voltage Conversion/Distribution and Low-Voltage Utilization Systems for additional details.

2.1.4 Utilities Distribution. The underground mains and feeders shall provide for the utilities distribution to the maintenance hangar service points and parking apron service points. The compressed air lines and electrical conduits shall be routed in the same trench. The access manholes shall be provided outside the paved areas. For cable-pulling manholes, refer to MIL-HDBK-1004/2, Power Distribution Systems.

2.1.5 Site Configuration. The layout of FPUS shall be subject to the correlated siting of maintenance hangars, parking apron space and taxiways. For the relationship of hangars to aircraft parking areas and taxiways, refer to NAVFAC DM-21 series, Airfield Pavement Design. The parking apron layout is prescribed in NAVFAC P-80, Facility Planning For Navy and Marine Corps Shore Installations. For a typical FPUS layout to serve a prescribed hangar and parking apron complex see Figure 1. The following criteria apply:

a) The central equipment facility shall be located as near the hangar as practical at a location offering the most direct access to the parking apron. Minimize the length of the underground mains to the parking apron.

b) Locate the section of underground mains between the central facilities and the first transition point outside the apron and taxiway pavements.

c) The underground compressed air distribution piping should be arranged with loops to equalize distribution line pressure throughout.

d) A feeder distribution center consists of pad-mounted equipment located off the apron as close as practical to the service points to minimize aircraft service voltage drop. In some cases, however, for site reasons feeder distribution centers for apron service points may be located in the hangar. Refer to MIL-HDBK-1004/5 for sample voltage drop calculations. See Tables 6 and 7 of MIL-HDBK-1004/5 for maximum system distances. See Figure 10 for additional details.

2.2 Utility System Load Determinations. The total number and type of aircraft plus the demands of other ground support activities to be supplied by the fixed point facilities will determine load requirements for the utility system.

2.2.1 Aircraft Utility Demands. The utility demands required for the support of various aircraft are itemized in Table 1. The following aircraft unit demands shall be used as the minimum FPUS design criteria:

2.2.2 System Load Diversity. The system load diversity shall be determined by obtaining the system load diversity factor from Figure 2. Divide the diversity factor into the total number of aircraft under consideration to determine the number of aircraft expected to exert a simultaneous demand.

2.2.3 System Load Demands. The system load demands shall be determined by multiplying the aircraft unit demand by the expected simultaneous demand for the portion of the system under consideration. Refer to par. 2.2.1 for aircraft minimum unit demand criteria.

2.3 Starting Air System. The starting air system shall provide only compressed air for aircraft engine starting and for pneumatic tool operation at parking apron service islands and maintenance hangar service points. The system design shall comply with standards specified in NAVFAC DM-3.05, Compressed Air and Vacuum Systems. See Figures 13 and 14 for aircraft service console mechanical schematic information.

Table 1
Summary of Aircraft Utility Demands

AIRCRAFT SERIES	AIRCRAFT ENGINES		ELECT	AIR START SYSTEM STARTING AIR[3]		PRECONDITIONED COOLING AIR[5]		ECS COMPRESSED AIR	
	No.	TYP E	400 HZ kVA [2]	lb/min[4]	psig	lb/min[6]	psig	lb/min	psig
A-4E	1	J52		85.0	45	30.00	3	NA[7]	NA[7]
A-6A	2	J52		85.0	45	50.00[8]	2	35.00	45
A-6G	2	J52		85.0	45				
A-7E	1	TF4 1		85.0	45	32.00	3	60.00	45
F-4J	2	J79		180.0	75	30.00	3	50.00	45
F-14A	2	TF3 0		85.0[8]	45	48.92[9]	3	110.00	45
F-14D	2	TF3 0		180.0[8]	75	40.92	3	110.00	75
F-18[10]	2	F11 O- 400		132.0	45	50.00	3	110.00	45
S-3A	2	F40 4		85.0	45	100.00	3	80.00	45
P-3C	4	F40 4		150.0	45	50.00	3	122.00	45
E-2C	2	TF3 4		85.0	45	100.00	3	30.00	45
EGC-130	4	T56		[11]	[11]	[11]	[11]	[11]	[11]
EA-6B	2	T56		85.0	45	77.00	1.5	70.00	75
E6-A	4	T56		[11]	[11]	[11]	[11]	[11]	[11]
SH-60B	2	T56		85.0[12]	45[12]	50.00[12]	3[12]	100.00[12]	45[12]
SH-60F	2	J52		[11]	[11]	[11]	[11]	[11]	[11]
C/MH-53E	3	CFM 56		[11]	[11]	[11]	[11]	[11]	[11]
		T70 0							[11]
		T40 0							[11]
		T64							[11]

Table 1 (Continued)
Summary of Aircraft Utility Demands

NOTES:

- (1) For specific information on aircraft not listed, contact NAVAIR 8.0Y1G on DSN 664-1104.
- (2) Refer to MIL-HDBK-1004/5 for values.
- (3) Requirements per engine.
- (4) NAEC-GSED-86, Fixed Point Aircraft Utility Support System Report.
- (5) Nominal capacity at 45 degrees F supply air (hangar locations only).
- (6) Analysis of Fixed Point Utility System - Supplement "86" Report.
- (7) ECS not available for A-4E aircraft.
- (8) For air start system demand calculations, assume F14s only start one engine, and use cross bleed air to start second engine from the first.
- (9) Manufacturer's information.
- (10) For demand calculations, prior to adjusting for diversity, include only 20 percent of the F18 aircraft in the count for use with Figure 2, the diversity curve, the remaining 80 percent will use their on board auxiliary power units to provide electricity, air start, and cooling capability.
- (11) Data to be provided by NAVAIR after testing is completed.
- (12) Values are theoretical not equipped for external air connections.

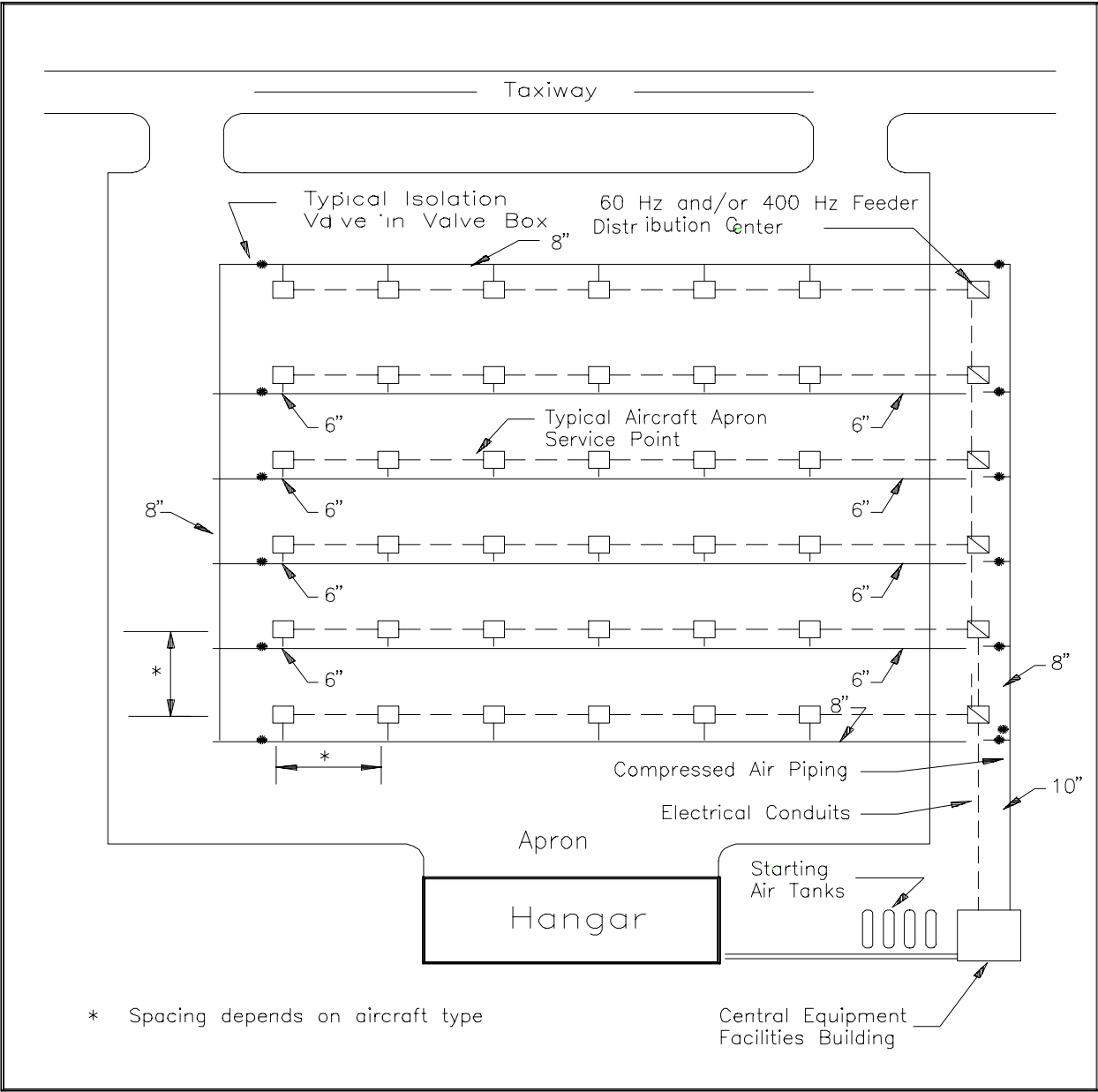

Figure 1
Typical FPUS Site Plan

2.3.1 System Components. A schematic diagram of the starting air system is shown in Figure 3. The basic components of the system are:

- a) Electric motor-driven, reciprocating-type air compressors,
- b) Air dryers,
- c) Compressor cooling system,
- d) Compressor and compressed air system controls,
- e) Receiver storage tanks,
- f) Underground distribution system, and
- g) Aircraft hangar and parking apron service point facilities.

2.3.2 Design Requirements. A broad range of starting air requirements exists because of differences in aircraft types and functions of the squadron or group. The starting air system shall have a minimum compressor size and receiver tank storage capacity to supply air for the starting (in 2 minutes) 12 of a full complement of 36 two-engine aircraft with a 2-hour recovery period. Section 3 relates this criteria requirement to designs for less than a full complement of aircraft.

2.3.3 Design Conditions. The equipment ratings shall be based on standard ambient conditions of 14.67 psia (101.13 kPa) atmospheric pressure and 70 degrees F (21 degrees C) dry bulb temperature. The system shall be designed to supply air at the parking apron service island in the quantity required measured at 45 psig (310.23 kPa) or 75 psig (517.05 kPa).

2.4 Environmental Control System. The function of the ECS is to provide compressed air for aircraft engine starting, ECS compressed air, and pneumatic tool operation at parking apron service islands and maintenance hangar service points. The ECS uses compressed air to operate the aircraft air cycle refrigeration machine which provides cockpit and cabin pressurization comfort conditioning, avionics and radar cooling, and other heating and cooling tasks. The system design shall comply with piping and installation standards specified in NAVFAC DM-3.05.

2.4.1 System Components. A schematic diagram of the environmental controls compressed air system is shown in Figure 4. Basic components of the system are:

- a) Electric motor-driven centrifugal or rotary-screw type compressors,
- b) Air dryers,
- c) Compressor cooling system,
- d) Compressor and compressed air system controls,
- e) Underground distribution system, and
- f) Aircraft hangar and parking apron service point facilities.

2.4.2 Design Requirements. A broad range of starting and cooling air requirements exists because of differences in aircraft types and operational function of the squadron or group. The ECS shall have a minimum compressor size to supply air for the simultaneous starting of 12 of a typical full complement of 36 two-engine aircraft or the cooling of 3 of a full complement of 36 aircraft. Because the ECS compressed air flow requirement is larger and is of longer duration than the starting air requirement, the ECS compressed air requirement is used to determine compressor size. With this requirement, all 12 aircraft can be started in 3 minutes with no recovery time required.

2.4.3 Design Conditions. For design conditions refer to par. 2.3.3.

2.5 Preconditioned Cooling Air System. Note: A study commissioned by NAVFACENCOM Criteria Office is underway relative to providing preconditioned cooling air. Results will be incorporated into this handbook when completed. See Figure 5.

2.6 Electrical System. The electrical system provides the main power supply and distribution for FPUS central equipment operations and central facilities building services, and distributes 400 Hz and 60 Hz power to parking apron service points and hangar service points. Provide load-center type unit substation to supply FPUS facility power from the naval air station primary distribution system. System design shall comply with electrical installation standards specified in MIL-HDBK-1004/1, Electrical Engineering, Preliminary Design Considerations, MIL-HDBK-1004/2, MIL-HDBK-1004/3, Switchgear and Relaying, MIL-HDBK-1004/4, Electrical Utilization Systems, MIL-HDBK-1004/5, and MIL-HDBK-1004/6, Lightning Protection, and National Fire Protection Association (NFPA) 70, National Electrical Code, and American National Standards Institute (ANSI) C2, National Electrical Safety Code.

2.6.1 System Components. Schematic diagrams of typical electrical systems for the ECS and air start system are shown in Figures 6, 7, 8 and 9. The basic components of the system are:

- a) Medium and low-voltage switchgear with main breaker and metering;
- b) Motor control center;
- c) 400 Hz, solid state converters (NAVFACENGCOM policy is to provide solid state frequency converters. Some motor-generator frequency converter 400 Hz systems exist, repairs and additions to these systems shall adhere to criteria contained herein and in MIL-HDBK-1004/5);
- d) Transformers and circuit breaker distribution panels;
- e) Underground distribution system with manholes and handholes as required;
- f) Electrical feeder distribution (see Figures 6, 7, 8, 9, and 10);
- g) Aircraft hangar service point and parking apron service point facilities (refer to MIL-HDBK-1004/5).

2.6.2 Design Requirements. A broad range of electrical requirements exists because of differences in aircraft types and operational function of squadron or group. The electrical demand for both the 60 Hz and 400 Hz shall be based on serving 12 of a full complement of 36 aircraft. The resulting demand is proportioned between parking apron service points and hangar service points with a ratio of 2 to 1 respectively. Section 3 relates this criteria requirement to designs for less than full complement of aircraft.

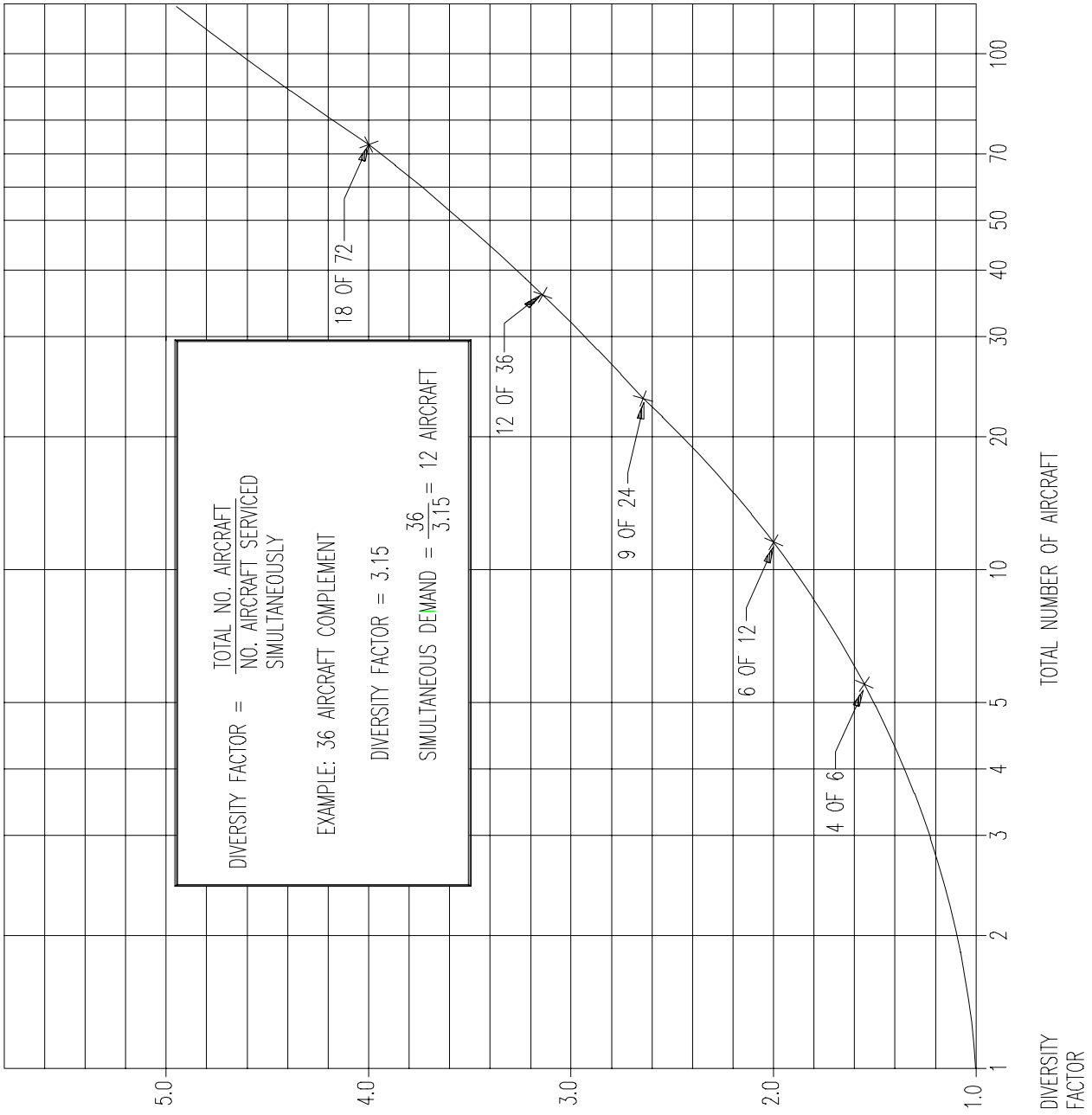

Figure 2
FPUS Diversity Curve

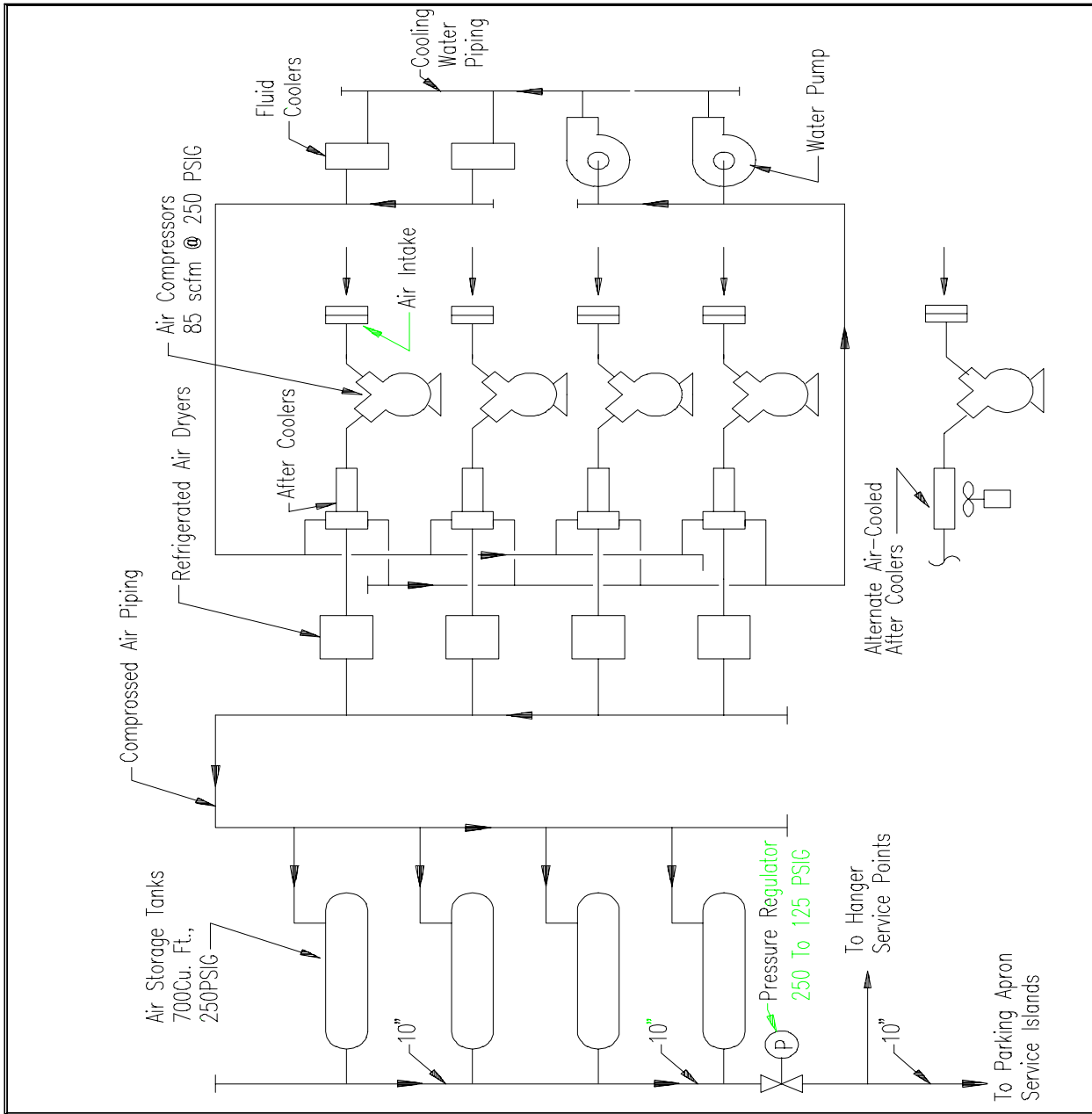

Figure 3
Starting Air System

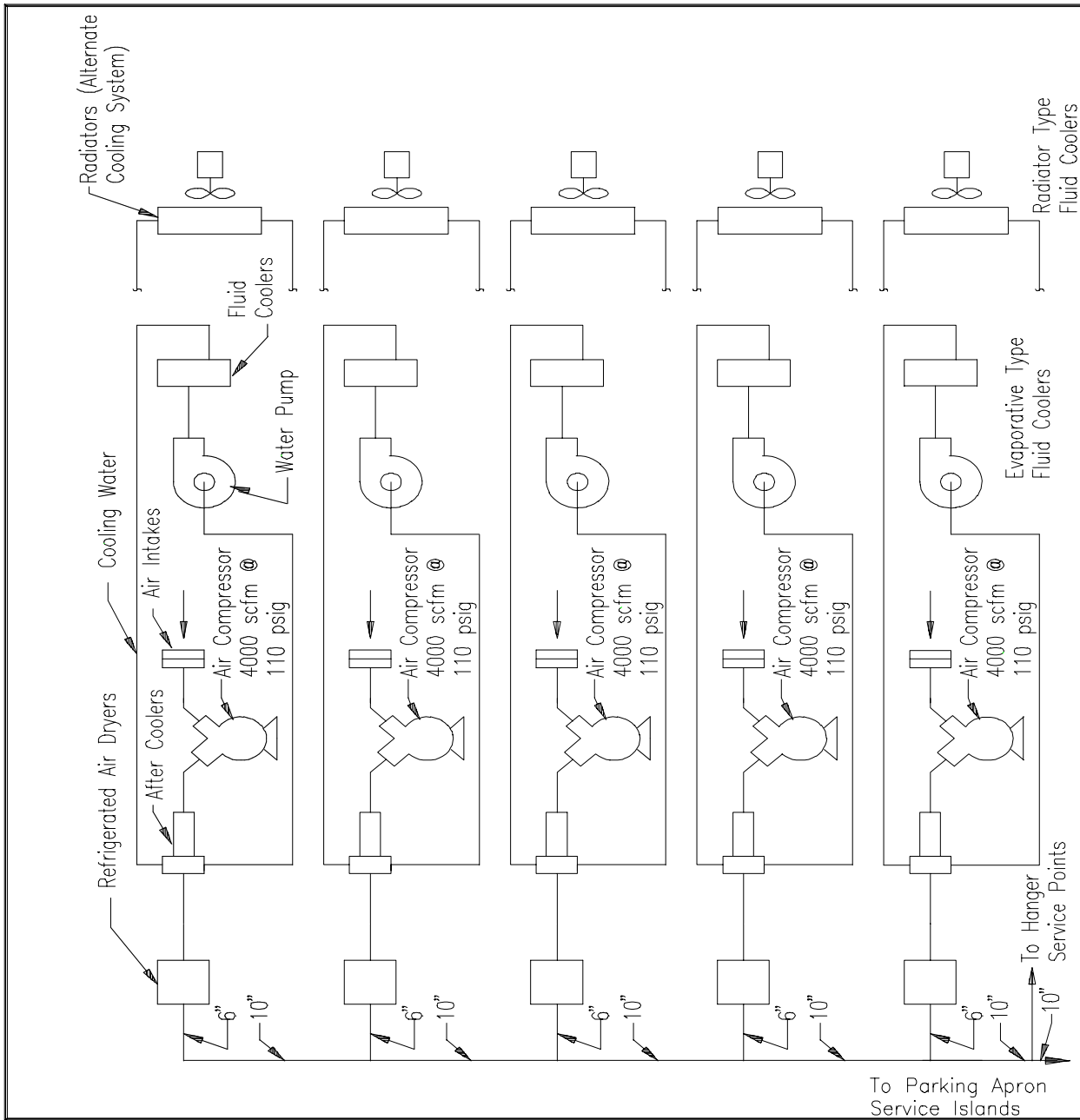

Figure 4
ECS Air System

(NOTE: A STUDY COMMISSIONED BY NAVFAC CRITERIA OFFICE IS UNDERWAY RELATIVE TO PRECONDITIONED COOLING AIR. RESULTS WILL BE INCORPORATED INTO THIS HANDBOOK WHEN COMPLETED.)

Figure 5
Preconditioned Cooling Air System

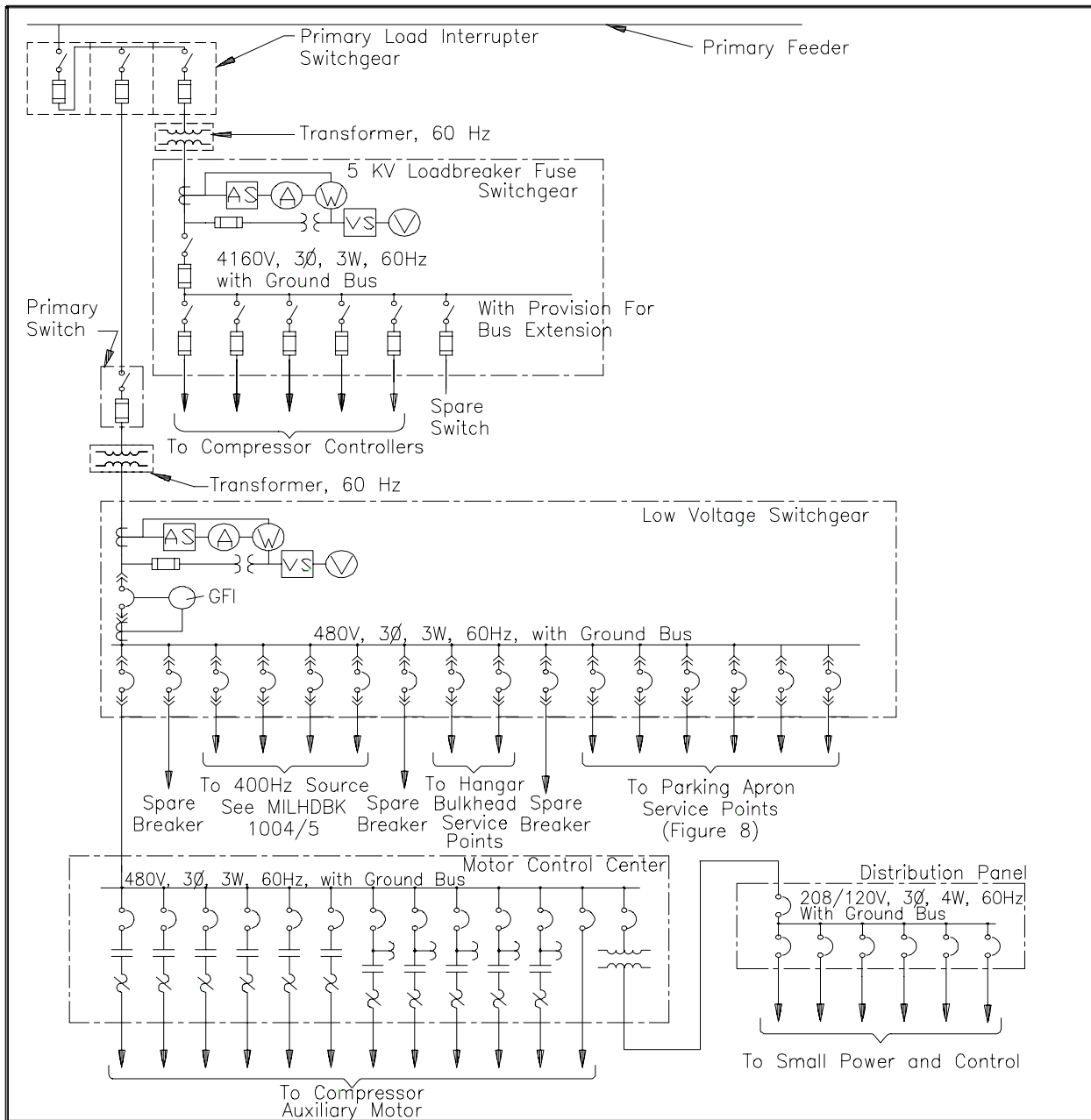

Figure 6
 Typical One Line Diagram Central Facilities - ECS System

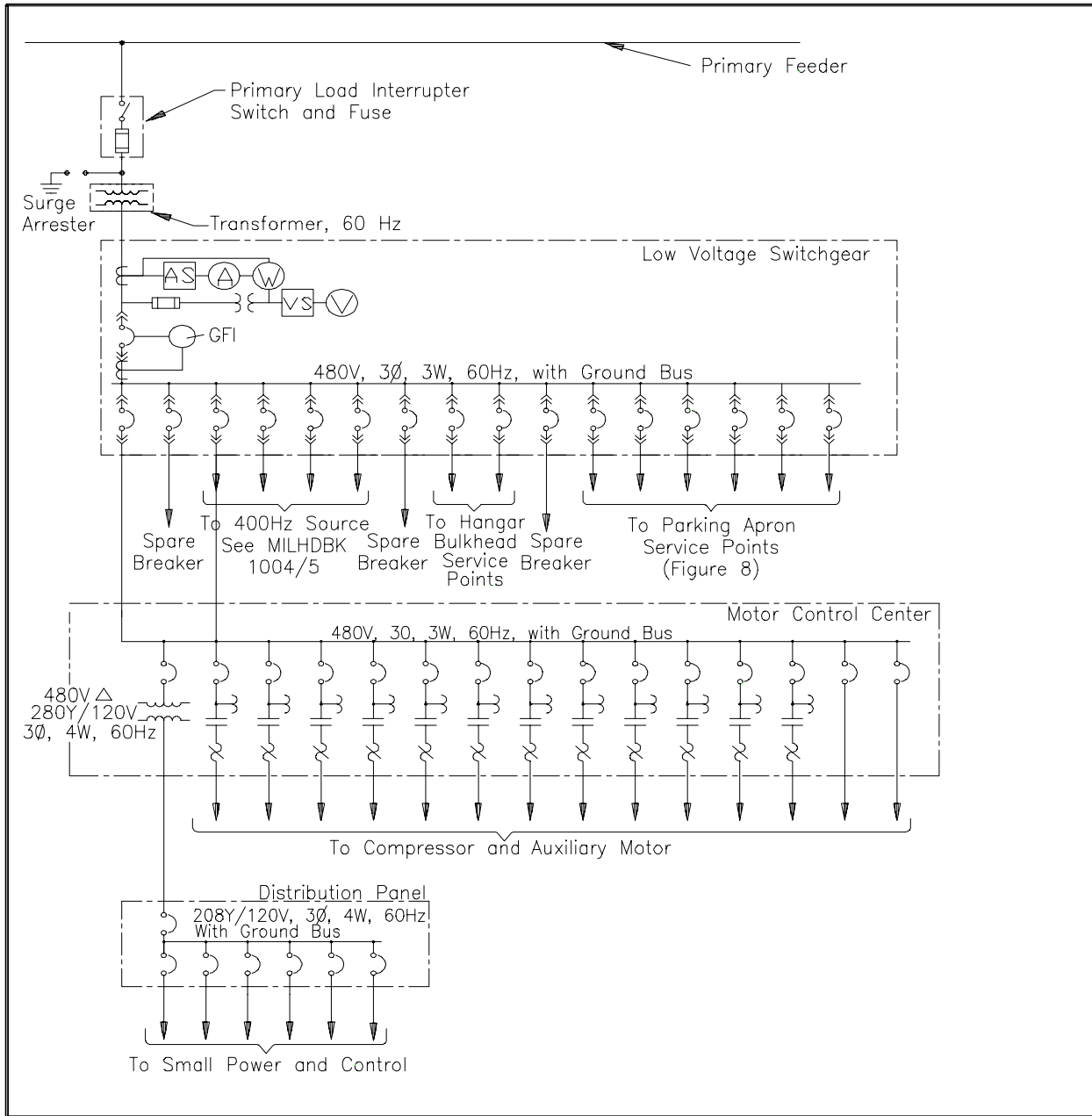

Figure 7
 Typical One Line Diagram Central Facilities Air Start System

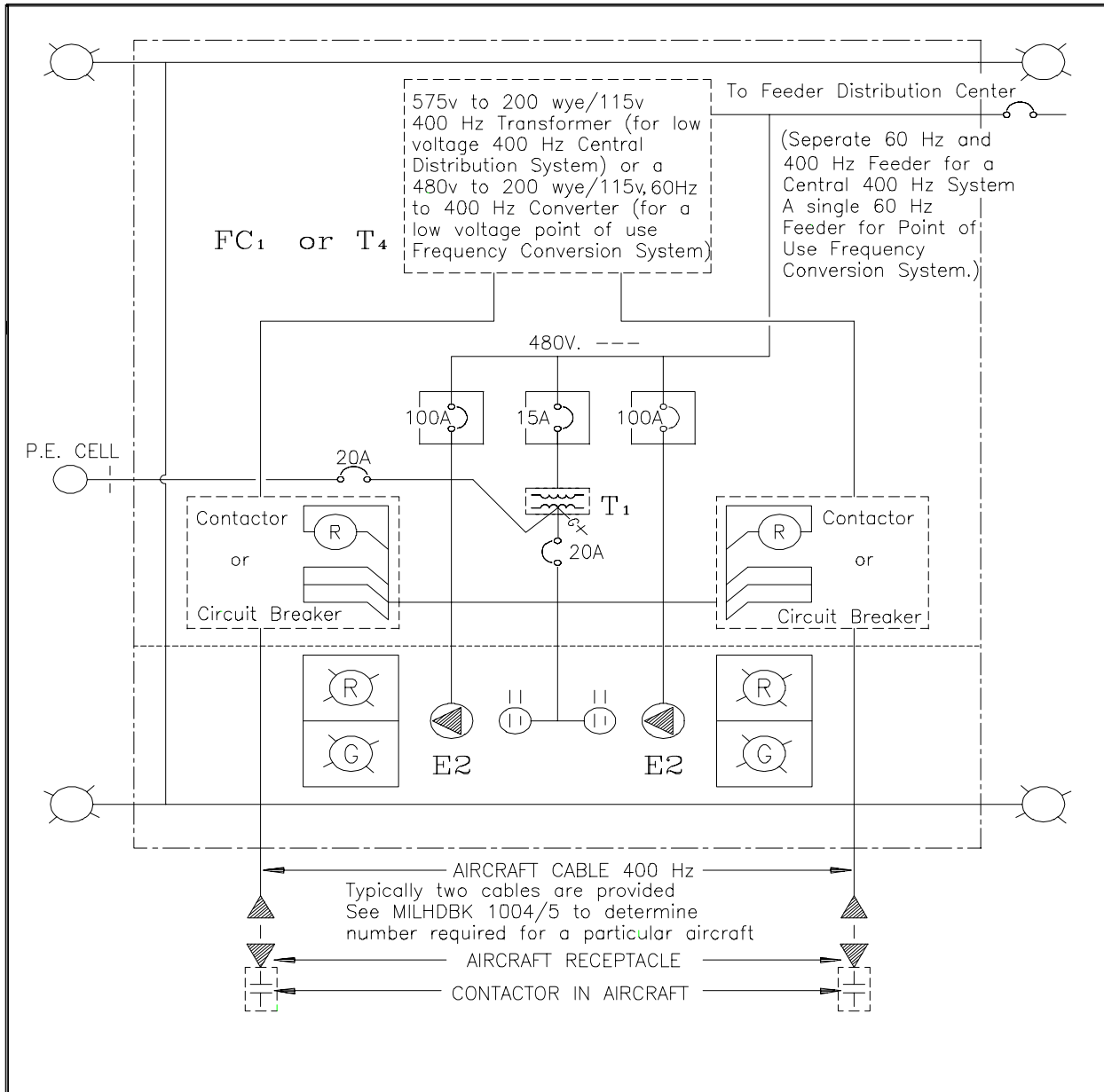

Figure 8
Typical Parking Apron Service Point Electrical One-Line Diagram

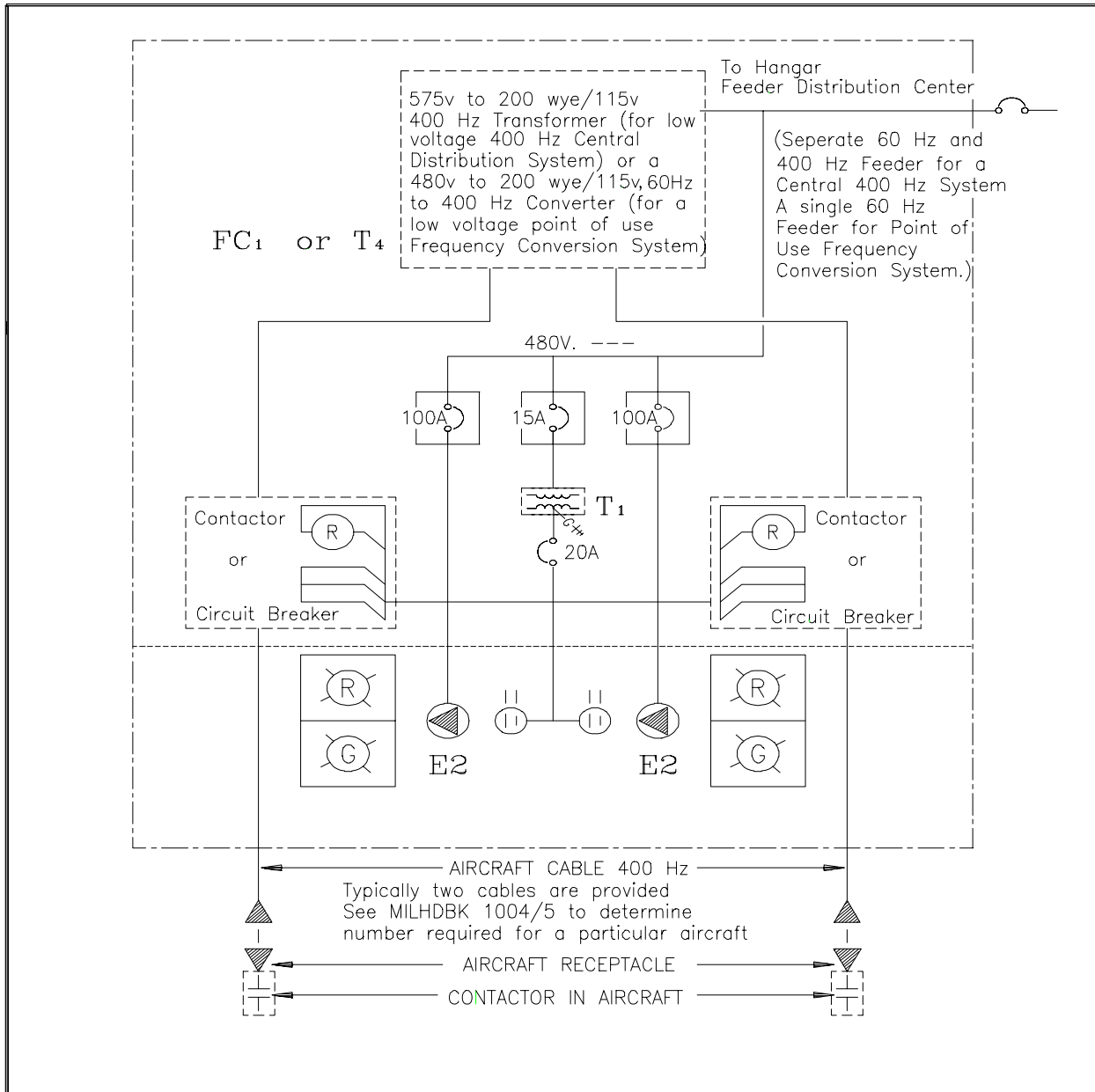

Figure 9
 Typical Hangar Service Point Electrical One-Line Diagram

The Distribution Center may include some or all of the equipment shown depending on whether the 400 Hz system is a Central 400 Hz Distribution System or a point of use Frequency Conversion System.

- ① PRIMARY SWITCH
- ② TRANSFORMER 4160-575V. 3 PHASE 400 Hz WITH HARMONIC FILTERS
- ③ 400 Hz LINE DROP COMPENSATOR
- ④ 400 Hz 575 VOLT CIRCUIT BREAKER
- ⑤ 480V 3 PHASE 60 Hz WIRE SPACE

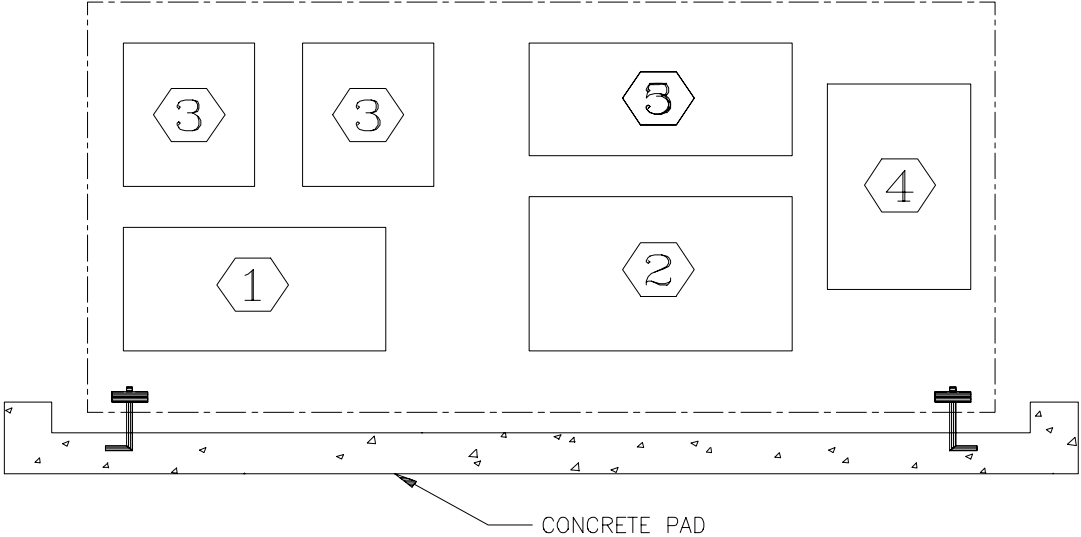

Figure 10
Feeder Distribution Center







SYMBOL	DEVICE
	FUSE
	SUBSTATION (Primary Switch, Internal Fusing, and Transformer)
	DRAWOUT CIRCUIT BREAKER
	CONTACTOR
	Air or Molded Case Circuit Breaker (depends on use)
	RECEPTACLE, CLASS L. 100A. 3P, 480V.
	RECEPTACLE, 120V GFI WEATHERPROOF TYPE
FC ₁	Frequency Converter 480v to 200 wye/115v, 60 Hz to 400 Hz with Harmonic Filtering
T ₁	TRANSFORMER 1 PHASE 120V, 60 Hz
T ₄	TRANSFORMER 3 PHASE 575V to 200 wye/115v, with Harmonic Filtering

Figure 11
FPUS Electrical Symbols

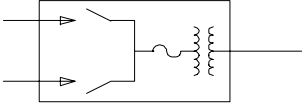



<u>SYMBOL</u>	<u>DEVICE</u>
	OBSTRUCTION LIGHT
P.E. CELL 	PHOTOCELL
	CONTACTOR/CIRCUIT BREAKER POSITION INDICATOR LIGHT CONTROL RELAY 120 VOLT AC
	RED INDICATING LIGHT
	GREEN INDICATING LIGHT FOR OFF POSITION

Figure 12
FPUS Electrical Symbols

SYMBOL	COMPONENT DESCRIPTION
VI	MAIN SHUTOFF VALVE 3 IN. BUTTERFLY VALVE, 200 PSI RATED, ALUMINUM-BRONZE DISC AND METAL-REINFORCED BUNA-N CARTRIDGE SEAT FOR BUBBLE-TIGHT SEAL ONE PIECE SHAFT, LUGGED BODY, WITH EXTENSION SHAFT AND MIN. EIGHT-POSITION LOCKING LEVER OPERATOR. MIN. FLOW 2700 SCFM AT 90 PSIG, WITH 2 PSI PRESSURE DROP.
V2	MAIN CONTROL VALVE, 3 IN. AXIAL FLOW VALVE WITH NITRILE RUBBER SEALING SLEEVE, CLASS 150 MAX. PRESSURE 250 PSIG OR GREATER, MIN. FLOW 2700 SCFM AT 90 PSIG IN, 78 PSIG OUT, WITH BOLTING SET FOR MOUNTING BETWEEN FLANGES EQUAL TO GROVE MODEL 83.
V3	OUTPUT PRESSURE SELECTOR VALVE, THREE-WAY BALL VALVE, 3/8 IN. NPT PORTS, BRASS CONSTRUCTION, PANEL MOUNTED WITH BLACK NYLON OR METAL LEVEL HANDLE, MIN. $C_v = 2.0$.
V4	OUTPUT BLOWDOWN VALVE, TWO-WAY, TWO PORT SPOOL VALVE BRONZE, WITH AIR PILOT AND SPRING RETURN. 1-IN. NPT PORTS, $C_{v\text{MIN}} = 8.0$ WITH EXHAUST MUFFLER EQUAL TO VERSA VSP 7702, W/SCHRADER 4816-1000 SILENCER.
V5	START CONTROL VALVE, TWO-WAY, TWO PORT SPOOL VALVE, WITH PALM BUTTON OPERATOR AND SPRING RETURN BRONZE, FOR PANEL MOUNTING 1/4 IN. NPT PORTS. $C_{v\text{MIN}} = 1.2$. NORMALLY CLOSED. EQUAL TO VERSA VSI-2301-P.
V6	STOP CONTROL VALVE. THREE-WAY, TWO-OUTLET BRONZE SPOOL VALVE WITH PALM BUTTON OPERATOR AND SPRING RETURN FOR PANEL MOUNTING. 1/4 IN. NPT PORTS. $C_{v\text{MIN}} = 1.2$. EQUAL TO VERSA VSI-7302-P W/DUST EXCLUDER AT EXHAUST.
V7	START CONTROL LATCH VALVE. THREE-WAY, TWO-OUTLET BRONZE SPOOL VALVE WITH AIR PILOT AND SPRING RETURN. 1/4 IN. NPT PORTS, $C_{v\text{MIN}} = 1.2$. EQUAL TO VERSA VSP-7302 W/DUST EXCLUDER AT EXHAUST.
V8	START LATCH SHUTTLE VALVE. TWO-INLET, ONE-OUTLET, BRASS CROSS SHUTTLE VALVE 3/8 IN. NPT PORTS. $C_{v\text{MIN}} = 1.2$. EQUAL TO VERSA SV-4.
V9	OPENING SPEED CONTROL VALVE. MICROMETER ADJUST NEEDLE VALVE, 1/4 IN. NPT PORTS, BRASS W/SS TRIM, BUNA-N SEALS, WIDE OPEN $C_{v\text{MIN}} = 0.60$.

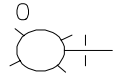
Figure 14
Aircraft Service Mechanical Symbols

SYMBOL	COMPONENT DESCRIPTION
V10	CLOSING SPEED CONTROL VALVE. SIMILAR TO V9. 3/8 IN. NPT PORTS. MIN $C_v = 0.60$.
V11	START-LOCKOUT PRESSURE ADJUSTMENT VALVE. SIMILAR TO V9, 1/4 IN. NPT PORTS. $C_{v\text{MIN}} = 0.30$.
V12	PRIMARY REGULATOR ISOLATION AND EXHAUST VALVE. THREE-WAY, TWO-OUTLET BRONZE SPOOL VALVE, WITH AIR PILOT AND SPRING RETURN. 1/4 IN. NPT PORTS. $C_{v\text{MIN}} = 1.2$. EQUAL TO VERSA VSP-7302. W/DUST EXCLUDER AT EXHAUST.
V13	BLOW-OFF VALVE. 1/2 IN. BALL VALVE W/CAP AND CHAIN.
V14	UTILITY AIR SHUTOFF VALVE. 1/2 IN. NPT BRONZE BALL VALVE, WITH LEVER HANDLE. WIDE OPEN $C_v = 9.0$.
V15	UTILITY AIR PRESSURE REGULATOR. 100 SCFM AT 130 PSIG INLET. 5 PSI PRESSURE DROP. SPRING-LOADED DIAPHRAGM TYPE, ADJUSTABLE, NON-BLEED RELIEVING.
V16	CONTROL TRAY SUPPLY AIR ISOLATION VALVE. SAME AS V14. ONLY 3/4 IN.
V17	OUTPUT LINE SURGE RELIEF VALVE. SET 90 PSIG. DISCHARGE 1200 SCFM TO ATMOSPHERE AT 100 PSIG. 2 IN. NPT.
V18	PRIMARY PRESSURE REGULATOR (FOR V2), AIR LOADED, 1 IN. CAST IRON BODY, NEOPRENE DIAPHRAGM, BUNA-N VALVE DISC. HIGH PRESSURE VERSION 1/4 IN. ORIFICE.
F1	UTILITY AIR FILTER. 100 SCFM AT 125 PSIG, WITH 5 PSI INITIAL PRESSURE DROP, METAL BOWL. AUTO DRAINER, 1/2 IN. NPT PORTS. 5 MICRON ELEMENT. 3/4 IN. NPT.
F2	CONTROL AIR FILTER, 100 SCFM AT 100 PSIG WITH 5 PSI INITIAL PRESSURE DROP, METAL BOWL, AUTO DRAINER. 1/2 IN. NPT PORTS. 5 MICRON ELEMENT.
C1	CONTROL TRAY SUPPLY AIR CONNECTOR. GALVANIZED MALLEABLE IRON PIPE UNION. 150 POUND. BRASS SEAT, NUT TYPE WITH BUNA-N O-RING.
C2	CONTROL TRAY SENSING/BLOWDOWN CONNECTOR. 1 IN. NPT.

Figure 14 (Continued)
Aircraft Service Mechanical Symbols

SYMBOL	COMPONENT DESCRIPTION
C3	V4 CONNECTOR. 1 IN. NPT.
M1	UTILITY AIR OUTPUT CONNECTOR. 100 SCFM AT 7 PSIG (MAX.) PRESSURE DROP. 120 PSIG. 1/2 IN. MALE PT. BRASS AND 55 CONSTRUCTION.
M2	CONSOLE OUTPUT AIR LINE CONNECTOR. 3 IN. FLEXIBLE HOSE CONNECTION POINT.
M3	AIR LUBRICATOR. 100 SCFM AT 125 PSIG. 11 OZ. METAL BOWL, DIE CAST ZINC ALLOY BODY, FLEXIBLE PARTS ARE A BUNA-N OR POLYURETHANE.
P1	45 PSIG OUTPUT PRESSURE PILOT (FOR V18). 1/4 IN. NPT GENERAL PURPOSE AIR PRESSURE REGULATOR RELIEVING TYPE, ADJUSTABLE SPRING LOADING, DIAPHRAGM TYPE, SAFE WORKING PRESSURE 200 PSIG OR HIGHER, CAST METAL BODY.
P2	75 PSIG OUTPUT PRESSURE PILOT (FOR V18). SAME AS P1.
O1	START CONTROL BLEED ORIFICE. 1/4 IN. NPT BRASS PIPE PLUG, DRILLED ON CENTERLINE 0.10 IN.
G1	AIR MAIN PRESSURE GAUGE. 4 IN. DIAL. 0-200 PSIG PANEL MOUNTED, BACK CONNECTED, 1/4 IN. NPT CONNECTION, POLYAMID OR SS CASE, SAFETY GLASS LENS, ADJUSTABLE POINTER, WATERTIGHT CASE.
G2	OUTPUT AIR PRESSURE GAUGE. SAME AS G-1 EXCEPT 0-100 PSIG.
G3	START LOCKOUT PRESSURE ADJUSTMENT GAUGE 2-1/2 IN. DIAL. 0-200 PSIG, 1/4 IN. NPT BOTTOM CONNECTION, SS CASE, SAFETY GLASS LENS, WATERTIGHT CASE.
G4	UTILITY AIR PRESSURE GAUGE 2-1/2 IN. DIAL 0-200 PSIG REAR FLANGE. 1/4 IN. NPT BACK CONNECTION. SS CASE WITH SAFETY GLASS LENS.

Figure 14 (Continued)
Aircraft Service Mechanical Symbols

Section 3: SYSTEM COMPONENT SELECTION

3.1 Standardization of Components. Standardization of FPUS components requires that central facilities equipment and main distribution components be selected for energy-efficient operation and according to the basic design methods defined in pars. 3.1.1 through 3.1.4.

3.1.1 Minimum Unit Demands. The minimum aircraft unit demands for aircraft ground support are as detailed in par. 2.2.1.

3.1.2 Maximum Unit Capacities. The maximum unit capacity of central facilities equipment shall be based upon the number of ground support equipment (GSE) available to serve as standby. Generally, that availability will be approximately one-fourth of the central facilities total demand as determined in Section 2.

3.1.3 Design Methods. The preceding requirements of aircraft unit demands, diversity of loads, minimum unit demand, and maximum capacities of central facilities equipment, when properly coordinated, formulate the design method. The design method is formulated on the basis of the requirements of carrier-type aircraft. The number of general purpose or special mission aircraft assigned to a particular facility is unpredictable. For such applications, determine the total utility demand by dividing the product of the aircraft unit demand and the number of aircraft by the diversity factor.

3.1.4 Design Method Summaries. Tables 2 through 7 summarize the design method for the determination of the quantity and ratings of the central facilities equipment. Calculations are based on air at standard conditions of 14.7 psia (101.35 kPa), 68 degrees F (20 degrees C), 36 percent relative humidity.

3.1.4.1 Selecting Starting Air Equipment. Table 2 summarizes the method for selecting starting air equipment. Table 3 presents an example for a starting air system based upon the following conditions:

- a) Compressor discharge pressure = 250 psig (1723.5 kPa)
- b) Pressure drop, compressor-to-receiver = 10 psig (68.94 kPa)
- c) Pressure drop, PRV to service point = 20 psig (137.88 kPa)
- d) Pipeline volume = 2300 cu. ft. (64.4 cu. m) at an average pressure of 115 psig (792.81 kPa)

The above information is necessary to determine the allowable system pressure drops. The minimum pressure required in the receivers for this example is 65 psig (448.1 kPa) which equals 45 psig (310.23 kPa) service point pressure plus 20 psig pipeline pressure drop. The maximum receiver pressure is 240 psig (1,654.56 kPa) since 10 psig is lost in the piping system between the compressor discharge and the receiver inlet.

3.1.4.2 Selecting ECS Air Equipment. Table 4 is a summary of the method for selecting ECS air equipment.

a) An example of an ECS air system is provided in Table 5, based upon the following conditions:

(1) Compressor discharge pressure = 110 psig (758.34 kPa)

(2) Pressure drop, compressor to service point = 10 psig (68.94 kPa) at minimum load and not exceeding 65 psig (448.11 kPa) at maximum load.

b) A summary of the method for selecting preconditioned air equipment is provided in Table 6. An example for a preconditioned air system is provided in Table 7, based upon the following conditions:

(1) Ambient air at 100 degrees F (38 degrees C) dry bulb, 110 grains/lb moisture

(2) System pressure drop = 0.5 psig (3.447 kPa)

(3) Temperature gain, service point to aircraft = 2 degrees F (16.6 degrees C) dry bulb

(4) Supply fan of 44 brake horsepower, 90 percent efficient, 124,500 Btuh (36,478.5 W) heat gain each.

3.2 Starting Air System. The starting air systems shall comply with the requirements of NAVFAC DM-3.05. A compressor and auxiliary equipment shall be provided as a coordinated assembly by the air compressor manufacturer requiring a maximum of 30 bhp per 100 cfm (2.8 cu. m/min) of intake air. Compressors shall operate satisfactorily, individually, or in parallel with any combination of other units. A compressor and compressed air system controls shall be provided to provide fully automatic operation.

3.2.1 Air Compressor and Auxiliaries. Air compressors and the auxiliary assembly shall be provided as defined in pars. 3.2.1.1. through 3.2.1.11.

3.2.1.1 Compressor. Two-stage, vertical or horizontal, cross-head type, single or double-acting, water-cooled, oil-free style shall be provided.

Table 2
 Summary of Design Method for Quantities and Ratings, Central
 Facilities Equipment Selection, Starting Air System

BASIS OF DETERMINATION FOR RECOMMENDED UNIT AND NUMBER OF EQUIPMENT UNITS:	CAPACITY
<u>Step</u>	<u>Description</u>
1.	Number and type of aircraft:
2.	Aircraft service requirements: Starting air = lb/min psig (per engine) Electrical = kVA, Hz
3.	Aircraft to be served simultaneously: <u>Total number of aircraft</u> = aircraft to be served Diversity factor
4.	Number and location of services to be provided: Starting air = number, flight line Electrical = number, hangar Electrical = number, flight line
5.	System capacity: Starting air storage capacity: Number aircraft x lb/min x min x (no. engines)** = lb Storage vol., std. cu. ft. (scf) = lb x specific volume Pipeline equiv. vol.= <u>pipe vol. x allowable pressure drop</u> atmospheric pressure Receiver capacity= <u>(stor.vol.-pipe equiv.)x atmos. press.</u> allowable pressure drop Starting air compressor capacity: <u>Storage, volume, scf</u> = scfm Recovery time, minutes Electrical capacity: Number aircraft x kVA/aircraft = kVA
6.	Equipment unit size: <u>Total system capacity (Item 5)</u> = unit capacity *Number of units
7.	Select manufacturer's standard size that meets or exceeds unit capacity calculated

* Recommended number of units is 4 (selected for 25 percent of total system capacity).

** Refer to Table 1.

Table 3
Example of Design Method Starting Air System

RECOMMENDED UNIT CAPACITY	
<u>Step</u>	<u>Description</u>
1.	Number and type of aircraft: <u>36 F-14 aircraft</u>
2.	Aircraft requirements: Starting air = 85 lb/min 45 psig 2 engines *Electrical = 20.0 kVA, 400 Hz
3.	Aircraft to be served simultaneously: <u>36 aircraft</u> _____ = 12 aircraft 3.0 diversity factor
4.	Number and location of services to be provided: Starting air = 12 on flight line Electrical = 4 in hangar Electrical = <u>8 on flight line</u>
5.	System capacity: Starting air storage capacity: 12 aircraft x 85 lb/min x 1 min x 2 engs = 2040 lb 2040 lb x 13.33 scf/lb = 27,192 scf (total) 2300 cf x <u>115-65 psig</u> = 7823 scf (pipeline) 14.7 psi <u>27,192-7823 scf</u> x 14.7 psi = 970 scf (receiver) 240-65 psig Starting air compressor capacity: <u>27,192 scf</u> = 230 scfm 120 min Electrical: <u>12 aircraft x 20 kVA/aircraft = 240 kVA</u>
6.	Equipment unit size: Starting air: (receiver capacity) <u>970 scf</u> = 245 scf 4 Starting air: (compressor capacity) <u>230 scfm</u> = 57 scfm 4
7.	Select 4 compressors at 55 scfm 250 psig each and 4 nominal 250 scf storage tanks.

*Includes Spare Capacity - see Table 1.

Table 4

Summary of Design Method for Quantities and Ratings, Central Facilities Equipment Selection, and Environmental Control Air System

BASIS OF DETERMINATION FOR RECOMMENDED UNIT CAPACITY AND NUMBER OF EQUIPMENT UNITS:

<u>Step</u>	<u>Description</u>
1.	Number and type of aircraft:
2.	Aircraft service requirements: ECS air = lb/min psig (per engine) <u>Electrical = kVA, Hz</u>
3.	Aircraft to be served simultaneously: <u>Total number of aircraft</u> = aircraft to be served Diversity factor
4.	Number and location of services to be provided: Preconditioned air = number, hangar ECS air = number, flight line (aircraft served less number, hangar) <u>Electrical = number, hangar</u> <u>Electrical = number, flight line</u>
5.	System capacity: ECS air compressor capacity: Number, flight line x lb/min x specific vol. scf/min Electrical: Number aircraft x kVA/aircraft = kVA
6.	Equipment unit size: <u>Total system capacity (Item 5)</u> = unit capacity *Number of unit modules Select manufacturer's standard size that meets or exceeds unit capacity calculated.

* Recommended number of unit modules is four. (For large capacity systems, the preferred compressor selection is three units at 25 percent system total with the fourth module divided into two units at 12.5 percent each.)

Table 5

Example of Design Method, Environmental Control Air System

RECOMMENDED UNIT CAPACITY

<u>Step</u>	<u>Description</u>
1.	Number and type of aircraft: 36 F-14 aircraft
2.	Aircraft service requirements: ECS air = 100 lb/min 45 psig <u>Electrical = 20.0 kVA, 400 Hz</u>
3.	Aircraft to be served simultaneously: <u>36 aircraft</u> = 12 aircraft 3.0 diversity factor
4.	Number and location of services to be provided: Preconditioned air = 4 in hangar ECS air = 12 on flight line <u>Electrical = 8 on flight line</u> <u>Electrical = 4 in hangar</u>
5.	System capacity: ECS air compressor capacity: 12 aircraft x 100 lb/min x 13.33 scf/lb = 16,000 scfm Electrical: <u>12 aircraft x 20 kVA = 240 kVA total demand</u>
6.	Equipment unit size: ECS air: (compressor capacity) <u>16,000 scfm</u> = 4000 scfm 4
7.	Select three compressors at 4000 scfm and two at 2000 scfm, all at 110 psig discharge pressure.

Table 6

Summary of Design Method for Quantities and Ratings, Preconditioned
Air Equipment Selection

NOTE: A STUDY COMMISSIONED BY NAVFACENCOM CRITERIA OFFICE IS UNDERWAY RELATIVE TO PRECONDITIONED COOLING AIR. RESULTS WILL BE INCORPORATED INTO THIS HANDBOOK WHEN COMPLETED.

Table 7
Example of Design Method, Preconditioned Air System

NOTE: A STUDY COMMISSIONED BY NAVFACENCOM CRITERIA OFFICE IS UNDERWAY RELATIVE TO PRECONDITIONED COOLING AIR. RESULTS WILL BE INCORPORATED INTO THIS HANDBOOK WHEN COMPLETED.

3.2.1.2 Intercooler. Air-cooled finned-tube coil or water-cooled type, directly or remotely attached to compressor.

3.2.1.3 Motor. V-belt drive, open-drip proof, squirrel-cage, electric motor rated 460 V, three-phase, 60 Hz with 1.15 service factor.

3.2.1.4 Air Intake Filter Silencer. Dry-media type with disposable elements. Install filter silencer on compressor intake and design to attenuate intake noise to 84 dBA or less.

3.2.1.5 Aftercooler. (For warm climates above 85 degrees F (29.4 degrees C) design dry bulb.) Provide shell and tube water-cooled type mounted between compressor and air dryer. Furnish aftercooler with moisture separator, drain trap, and sight flow indicator.

3.2.1.6 Aftercooler (Alternate). (For cool climates 85 degrees F design dry bulb and below.) Provide horizontal or vertical draft finned tube heat exchanger with propeller type fan and electric motor all assembled on heavy-duty frame in a galvanized steel housing.

3.2.1.7 Oil Separator. Provide three-stage coalescing type with bolted and hinged access flange for removable filter media. The unit shall be installed between the system aftercooler and air dryer.

3.2.1.8 Refrigerated Air Dryer. Provide self-contained, commercial quality refrigeration system with moisture separator, condensate trap and all internal wiring and piping. Dryer shall be installed between oil separator and air receiver tank.

3.2.1.9 Cooling Water Assembly (for Water-Cooled Aftercooler). Closed circuit type with continuous cooling water recirculation shall include evaporative cooling coil, centrifugal forced draft fan, recirculating spray pump, electric motor drives, mist eliminators, and interconnecting piping mounted on a common steel base.

3.2.1.10 Circulating Pumps. Circulating pumps shall be end-suction centrifugal type installed inside the central facilities building.

3.2.1.11 Controls. Compressors and compressed air system shall be furnished with completely factory-assembled control system. Control system shall provide automatic capacity control (load sequencing) and safety controls for warning and equipment protection. A freestanding cabinet type control panel shall be furnished and installed near the compressors.

3.2.2 Air Receiver Storage Tanks. Air receiver tanks shall be horizontal, cylindrical, welded steel tanks designed for 250 psig working pressure in accordance with American Society of Mechanical Engineers

(ASME), Boiler and Pressure Vessel Code, Section VIII, Unfired Pressure Vessels. Coat tank interiors with corrosion-resistant, chemically inert material. Provide tanks with drain valve, automatic condensate trap, safety valve, air inlet and outlet connections, flanged manhole, and support saddles. Tanks shall be installed adjacent to the central facilities building and provided with concrete pads and fabricated steel support saddles.

3.2.3 Miscellaneous Equipment and Piping. Miscellaneous equipment and piping shall be furnished, installed, tested, and operated successfully. Piping systems and components shall conform to American National Standards Institute (ANSI) B31.1, Power Piping. Pipe, fittings, valves, and accessories shall be of the proper type for pressure and temperature of each piping system. Joints for ferrous piping shall be flanged, screwed, or welded. The piping system shall include the following:

3.2.3.1 Distribution System Pressure Control Valve. The pressure control valve shall reduce and maintain a constant system pressure of 125 psig (47.53 kPa).

3.2.3.2 Pressure Relief Valve. Pressure relief valve shall protect distribution system components from overpressure in excess of 140 psig (965.16 kPa).

3.2.3.3 Piping. Pipe shall be American Society for Testing and Materials (ASTM) A53, Pipe, Steel, Black and Hot-Dipped, Zinc-Coated, Welded, and Seamless, Grade B, carbon steel seamless Schedule 40 for sizes 2-1/2 in. (63.5 mm) and larger; Schedule 80 for sizes 2 in. (50.8 mm) and smaller. Refer to ASTM A53.

3.2.3.4 Miscellaneous Equipment. Miscellaneous equipment at aircraft service points are itemized in Section 6.

3.2.4 Distribution System. Compressed air shall be distributed to hangar and parking apron in underground lines, with cathodic protection, in common trench with electrical duct bank. Compressed air distribution pressure shall be 125 psig (861.75 kPa) gauge at 60 degrees F (15.5 degrees C). Pipe shall be of carbon steel welded construction with polyethylene coating, and shall be direct buried. Distribution header shall be run from central facilities to apron loop and connect isolated feeder lines to serve service islands. Slope compressed air distribution piping system to drain at low points, provide drains, and a means to solvent flush the system to allow cleanup after fuel or lube oil spills into system.

3.3 Environmental Control Cooling Air System. The design of the environmental control cooling air system shall comply with the requirements of MIL-HDBK-1003/3, Heating, Ventilating, Air Conditioning,

and Dehumidifying Systems and DM-3.05. Furnish compressor and auxiliary equipment as a coordinated assembly by the air compressor manufacturer requiring a maximum of 23 bhp for each 100 cfm (2.8 cu. m/min) of intake air. Compressors shall operate satisfactorily, individually, or in parallel with any combination of other units. Furnish compressor and compressed air system controls to provide fully automatic operation.

3.3.1 Air Compressor and Auxiliaries. Provide compressors and the auxiliary assembly as defined in pars. 3.3.1.1 through 3.3.1.10.

3.3.1.1 Compressor. Provide a multiple-stage, water-cooled, oil-free style centrifugal or rotary screw type compressor.

3.3.1.2 Intercoolers and Aftercooler. Provide shell and tube type intercoolers and aftercoolers, either both water-cooled or both air-cooled with moisture separator and drain trap.

3.3.1.3 Drive Motor. Provide a 3600 rpm, squirrel cage, induction motor for centrifugal compressor and 1800 rpm, constant-speed, synchronous motor for rotary screw compressor. Also provide a drip-proof electric motor rated 5000 V, three-phase, 60 Hz.

3.3.1.4 Air Intake Filter-Silencer. Provide a two-stage, dry media type air intake filter-silencer with disposable elements. The filter shall be installed between outdoor weathertight intake hood and compressor intake and shall be designed to attenuate noise.

3.3.1.5 Oil Separator. Provide a three-stage coalescing type oil separator with bolted and hinged access flange for removable filter media. Install the unit shall be installed between the compressor discharge and air dryer.

3.3.1.6 Refrigerated Air Dryer. Provide a self-contained, commercial quality refrigeration system shall be provided with moisture separator, condensate trap and internal wiring and piping. Install dryer between oil separator and main air line.

3.3.1.7 Cooling Water Assembly (Evaporative Type). Provide a closed-circuit type with continuous cooling water recirculation and include evaporative cooling coil, centrifugal forced draft fan, recirculating spray pump, electric motor drives, mist eliminators, and interconnecting piping mounted on a common steel base.

3.3.1.8 Alternate Cooling Water Assembly. Use a radiator type cooling water assembly for climates of 80 degrees F (27 degrees C) and below.

Provide a closed-circuit type cooling water assembly with continuous cooling water recirculation and horizontal air-cooled radiator type heat exchanger. Also provide propeller forced draft fans; a National Electrical Manufacturers Association (NEMA) Type 12 control cabinet housing electrical controls; motor starters; transformers and relays; and interconnecting piping mounted on a common steel base. As an option, the cooling water assembly shall include a circulating pump completely piped and wired to an integral control cabinet.

3.3.1.9 Circulating Pumps. Furnish and install circulating pumps of the end-suction centrifugal type:

- a) Inside the central facilities building or
- b) As an integral component of the radiator type cooling water assembly.

3.3.1.10 Controls. Provide compressors and a compressed air system with a completely factory-assembled control system. The control system shall provide automatic capacity control (load sequencing) and safety controls for warning and equipment protection. Also provide and install a freestanding cabinet type control panel near the compressors.

3.3.2 Miscellaneous Equipment and Piping. Furnish, install, test, and successfully operate miscellaneous equipment and piping. Piping systems and components shall conform to ANSI B31.1. Pipe, fittings, valves, and accessories shall be of the proper type for pressure and temperature of each piping system. Joints for ferrous piping shall be flanged, screwed, or welded. Provide isolation valves and piping required to remove any major component for servicing during system operation. The piping system shall meet the following criteria:

- a) Pipe shall conform to ASTM A53, Grade B, seamless carbon steel Schedule 40 for sizes 2-1/2 in. (63.5 mm) and larger, Schedule 80 for sizes 2 in. (51 mm) and smaller.
- b) Provide miscellaneous equipment at aircraft service points as itemized in Section 6.

3.3.3 Distribution System. Compressed air shall be distributed to hangar and parking apron in underground lines, with cathodic protection, in common trench with electrical duct bank. Compressed air distribution pressure shall be 100 psig (689.4 kPa) gauge at 60 degrees F (16 degrees C). Pipe shall be of carbon steel welded construction with polyethylene coating and shall be direct buried. Run distribution header from central facilities to apron loop and connect isolated feeder lines to serve service islands.

3.4 60 Hz Electrical System. The electrical systems shall comply with the requirements of MIL-HDBK-1004/1, MIL-HDBK-1004/6, and the NAVFAC DM-4 series, Electrical Engineering. System components shall be fully rated for the intended application.

3.4.1 Switchgear and Equipment. Obtain switchgear and equipment power from the existing station distribution system, hangar, or adjacent buildings. The electrical service shall be designed for the total power required for building supports and the FPUS equipment. Provide primary, fused, switch protection; lightning protection; substation-type service transformer; underground service entrance; low-voltage switchgear; secondary metering; lighting; small power transformers; and control panel. Service supplied from the primary distribution system at the site shall provide a substation-type transformer (if required). Transformers shall have a delta-connected primary and grounded wye-connected secondary.

3.4.1.1 Switchgear Assembly. Provide a 480 wye, 277 V, three-phase, four-wire, low-voltage switchgear assembly for power distribution in the building. Supply motor control center, parking apron service islands, hangar service points from switchgear. Also provide a 25 percent spare capacity for future requirements. Provide a unitized 480 wye, 277 V, three-phase, four-wire, 60 Hz motor control center for compressors and auxiliaries, ventilating fans, unit heaters and 480-208 wye, 120 V receptacle, and small power transformer.

3.4.2 Distribution System. 60 Hz power shall be distributed to hangar and parking apron service points by underground main feeders supplied from the 480 V, three-phase, low-voltage switchgear. Install underground feeders in concrete-encased, nonmetallic duct banks in accordance with NFGS-16302, Underground Transmission and Distribution.

3.4.2.1 Main Feeders. Main feeders shall be 480 V, three-phase, three-wire with color-coded, insulated, grounding conductor. Conductors shall be sized according to criteria unit demand with diversity applied for the number of service points connected (see Figure 2). Main feeders shall supply subfeeder circuit breakers located in parking apron distribution boxes. Subfeeder circuit breakers shall be rated 600 V, 225 amperes, three-pole.

3.4.3 Aircraft Grounding Point Requirements. Provide aircraft grounding points as required by MIL-HDBK-274, Electrical Grounding for Aircraft Safety.

3.5 400 Hz Electrical System. The 400 Hz electrical system shall supply aircraft electrical power requirements from frequency converters and utilization equipment as described in MIL-HDBK-1004/5. The system design shall provide for no-load to full-load voltage variations which are within the requirements of MIL-STD-704, Aircraft Electric Power Characteristics.

Section 4: CENTRAL FACILITIES BUILDING

4.1 General. The function of the FPUS central facilities is to provide a common source of supply for aircraft utilities and to provide protective shelter for the maintenance and repair of the central equipment. Emphasis shall be placed on siting to permit FPUS planning as described in par. 2.2.1. Refer to MIL-HDBK-1028/1, Aircraft Maintenance Facilities, for criteria and requirements.

4.2 Building. The building shall be a prefabricated metal building of modular design. For consideration of prefabricated structures, refer to NAVFAC DM-1 series, Architecture. The materials selected shall conform to 25-year economic life considerations for an industrial type building. The design shall include requirements for fire protection. In specific site locations where seismic forces are encountered, selection of materials and designs shall be in accordance with NAVFAC P-355, Seismic Design for Buildings.

4.2.1 Restrictions on the Use of Aluminum. Aluminum roofing and siding shall not be specified for structures located on or near the sea coast where the monthly rainfall is inadequate to keep surfaces washed clean and free from salt deposits or incrustation due to onshore winds and salt-laden atmosphere. Consideration shall be given to corrosion of aluminum on interior building surfaces. Aluminum surfaces shall be isolated from incompatible metals or material preservatives and masonry or concrete surfaces by treating with a heavy coat of alkali-resistant paint or by other approved means.

4.2.2 Architectural Requirements. Space allocations shall provide for flexible and economical equipment additions and an orderly expansion of the building. Space configuration shall be as required for the proper maintenance of the equipment to be installed and shall allow the installation of a monorail and traveling hoist to be installed under the roof framing in the approximate center of the building. The building design shall provide toilet facilities and heating, ventilating, and lighting equipment necessary for a proper working environment.

4.2.2.1 Walls. Walls shall consist of preformed, protected sheet metal panels with blanket insulation with vapor barrier on interior side. Furnish liner panels of preformed, protected sheet metal for interior wall areas.

4.2.2.2 Roof. The roof shall consist of preformed, protected sheet metal panels with blanket insulation and vapor barrier on the interior side (exposed ceiling).

4.2.2.3 Floors. Floors shall be concrete, finished using a wood float (making certain laitance is removed), and then surface-treated with a liquid chemical curing-sealing compound.

4.2.2.4 Entrances. The building shall have an entrance at each end consisting of a pair of flush hollow metal doors. Entrances shall have a concrete apron raised slightly above the finished grade.

4.2.2.5 Rooms. Separate rooms shall be provided for the mechanical systems and electrical switchgear in conformance with NFPA 70.

4.2.2.6 Floor Trenches. Floor trenches with removable steel covers shall be provided for compressed air piping and electrical conduits. The floor trenches shall be arranged to accommodate the compressed air and electrical connections, and to provide underfloor egress for the FPUS underground mains. The trench floor shall be sloped to drains provided at each end.

4.2.3 Structural Requirements. Structural designs shall be based on local live-load conditions, wind loading, and seismic conditions as governed by criteria for the specific site location. Local site frost lines and soil bearing capability shall be incorporated in the design. Refer to NAVFAC DM-2 series, Structural Engineering, for criteria and requirements.

4.2.3.1 Foundations. Generally, shallow spread footing foundations shall be used. The site soil conditions, however, could necessitate investigation of alternate type foundation systems. The exterior foundation system shall be a grade beam continuous over spread footings or pile caps, as required, at the building columns.

4.2.3.2 Building Frame. The building shall be of rigid frame, construction clear spanning the building width. The roof system shall have a slope of 2 in. (51 mm) vertical to 12 in. (305 mm) horizontal. Framing shall include roof purlins and wall girts. The structure shall support a monorail and traveling hoist with a 2000 lb (906 kg) capacity in the overhead space without interior columns.

4.2.3.3 Floor Structures. Floor shall be reinforced concrete slab-on-grade with a design to support the appropriate equipment and forklift wheel loads.

4.2.3.4 Equipment Pads. Equipment pads shall consist of reinforced concrete and shall be a minimum of 6 in. (152 mm) thick and designed to accommodate the particular equipment base. Pads for air compressors shall be isolated from floor slabs.

4.2.4 Mechanical Requirements. The mechanical systems shall comply with the standards specified in NAVFAC DM-3 series, Mechanical Engineering, and as defined in pars. 4.2.4.1 through 4.2.4.3.

4.2.4.1 Plumbing System. The facilities design criteria shall be as required by Building Officials and Code Administrators International Association (BOCA), International Plumbing Code, and shall provide for standard plumbing for toilet, floor, and floor trench drains. Provide drinking fountains.

4.2.4.2 Heating System. Building heating shall be as prescribed by MIL-HDBK-1003/3, provided by thermostatically controlled electrical, overhead, unit heaters. Capacity shall provide a minimum 65 degrees F (18.3 degrees C) space temperature. Equipment heat shall not be credited to heating load.

4.2.4.3 Ventilation System. Provide ventilation with wall-mounted exhaust fans and opposite wall intake louvers. Ventilation shall be as required by MIL-HDBK-1003/3 for both building and full equipment heat loads and sized to limit indoor and outdoor temperature differential to a maximum 10 degrees F (-12 degrees C) during summer season.

4.2.5 Electrical Requirements. The electrical systems shall comply with the standard requirements of NAVFAC DM-4 series. Components shall be rated for system application. See Figures 8 and 9 for electrical equipment details. Provide dry-type, 480-208 wye, 120 V, three-phase transformer with delta-connected primary and three-phase, four-wire distribution panel for convenience and small power supply. Provide convenience outlets (grounding type duplex receptacles) every 30 ft (9 m) of wall space.

4.2.5.1 Lighting. Provide a 208 wye, 120 or 277 wye, 480 V lighting system meeting the following criteria:

a) Lighting fixtures - refer to NFGS-16520, Exterior Lighting, for additional information.

b) Lighting levels - provide a lighting level in accordance with MIL-HDBK-1004/4.

4.2.5.2 Communications. Telephone, service entrance telephone cabinet, conduit runs, and telephone closet.

Section 5: FEEDER DISTRIBUTION CENTERS

5.1 Electrical Distribution. Provide pad-mounted enclosures for 60 Hz and 400 Hz equipment as required which may include transformers, switchgear, and associated devices (see Figure 10). Outdoor units shall be NEMA Type IV for parking apron. Hangar units shall be NEMA Type I. Refer to par. 2.1.5 for physical location criteria.

Section 6: UNDERGROUND INSTALLATIONS

6.1 Mains and Feeders. Fixed point-utility services shall be distributed to the hangar and parking apron in underground mains. The mains shall be installed in the same trench with access at the transition gate boxes. The routing of mains between the central facilities and the gate boxes shall be outside the apron and taxiway concrete as much as possible. Underground installation, including distribution box designs, shall conform to the requirements of NAVFAC DM-21.3, Flexible Pavement Design for Airfields and MIL-HDBK-1021/4, Rigid Pavement Design for Airfields.

6.1.1 Compressed Air Piping. Underground compressed air piping shall be carbon steel welded construction with a polyethylene coating. Pipe shall be laid on a 6 in. (152 mm) sand base with granular backfill. Horizontal and vertical alignment shall be maintained. Entrances to service islands shall be through sleeves with link seals. Underground piping shall have cathodic protection. The underground compressed air distribution piping should be arranged with loops to equalize distribution line pressure throughout. Depending on the system layout, sectionalizing valves may be provided for maintenance purposes.

6.1.2 Electrical. Electrical conduit shall be nonmetallic installed in concrete encased duct banks in accordance with NFGS-16302.

6.2 Service Access Points. Access to compressed air line valving shall be provided through flush-mounted valve boxes, valving shall provide isolation for line segments as indicated in Figure 1. Electrical feeders shall be terminated in feeder distribution centers and service point enclosures.

6.2.1 Valve Boxes. Compressed air shutoff valves on underground main loop and branch piping shall be installed in valve boxes flush with grade, with flush mounted removable cast-iron covers.

Section 7: AIRCRAFT SERVICE POINTS

7.1 Parking Apron Service Points. The function of the service point is to dispense compressed air and electrical services for aircraft ground support on the parking apron. Each island serves two aircraft. For details of construction and equipment installations see Figures 8, 11, 12, 13, and 14.

7.1.1 Construction. Service points shall have low profile design structures fabricated of steel angle frame with sheet steel side panel enclosures. Top panels are of one-piece formed aluminum and bolted to the frame. The enclosure is vented at top and bottom. The assembly is mounted on a concrete base pad approximately 6 in. (152 mm) above the apron grade. Service point structures shall be protected from vehicular traffic with concrete-embedded steel posts.

7.1.2 Mechanical Equipment Components. Compressed air piping and appurtenances shall be contained in rear half of the superstructure. Each island is served by a 3 in. (76 mm) line from the underground main. A 3 in. main shutoff valve shall be provided with moisture blow-off valves before and after. A 3 in. main pressure-reducing valve provided 45 psig (310.26 kPa) supply to a 3 in. flexible hose connector mounted externally on the end of the enclosure. Flexible aircraft starting air hose (Government-furnished equipment) is attached to the swivel joint. A pressure switch is provided at the outlet of the pressure-reducing valve which activates a low pressure warning light mounted on the exterior of the enclosure.

a) The pneumatic tool air is supplied by connection to the 3 in. service line before the main pressure reducing valve. The tool air piping shall contain the following:

- (1) Shutoff valve (V1),
- (2) Pneumatic tool filter (F2),
- (3) 90-psig (620.53 kPa) pneumatic tool air and pressure regulator (V15),
- (4) Pneumatic tool lubricator (M3), and
- (5) Two pneumatic tool quick-connectors mounted externally on the end of the enclosure (M-1).

b) Provide the following items and mount the items on the exterior side of the enclosure (see Figures 14, 15, and 16 for mechanical system details):

- (1) Main shutoff valve operating handle (V1),

- (2) Pressure gauge (supply air inlet to regulator),
- (3) Pressure gauge (starting air connection),
- (4) Main blow-off valve operator,
- (5) Strainer blow-off valve operator, and
- (6) Tool air shutoff valve operator.

7.1.3 Electrical Equipment Components. Electrical apparatus and service connection shall be contained in the forward half of the enclosure. Each point shall contain 60 Hz and 400 Hz components as follows.

7.1.3.1 60 Hz Components. The 60 Hz components shall be as follows:

- a) 60 Hz input circuit breaker(s) three-pole, 600 V. In situations where the 400 Hz converter is located at the apron service point, the input circuit breaker shall be sized to include the 400 Hz converter load. The circuit breaker shall be operated from the front of the service point enclosure.
- b) Two 100 ampere, three-pole, 600 V, 60 Hz, molded case circuit breakers, one breaker shall be mounted on the interior of each side panel.
- c) Two 100 ampere, 480 V, three-phase, four-wire, 60 Hz receptacles conforming to MIL-C-22992, Connectors, Plugs and Receptacles, Electrical, Waterproof, Quick Disconnect, Heavy Duty Type, (Class L), and MS90555-C-44-150S (Government-furnished equipment). This receptacle will match cable plugs MS90556C-44-151P, MS905556-C-44-152P, or MS90556-C-44-156P provided with the ground support equipment. One receptacle shall be mounted on the exterior of each side panel.
- d) One 3 kVA, one-phase, 480-120 V, 60 Hz, dry-type transformer with two-pole primary circuit breaker and a one-pole, 20-ampere secondary breaker. The transformer shall provide power for control, 120 V receptacles, and obstruction lights. The transformer and the protecting breakers shall be mounted on the interior sheet steel barrier between the mechanical and electrical sections.
- e) Two 20 ampere, 125 V, one-phase, two-pole, three-wire, 60 Hz, weatherproof receptacles with ground-fault interrupting. One receptacle shall be mounted on each of the exterior side panels.
- f) Four obstruction warning light fixtures shall be furnished for each service point enclosure. Fixtures shall consist of cast aluminum

body for bracket mounting and a red fresnel lens. Lamps shall be Type 116A21/TS, 117 W, 120 V, 60 Hz. Fail-safe photoelectric control shall be provided for fixtures at each service island. Fixtures shall be mounted near opposite corners of the superstructure.

g) One low-air-pressure warning light shall be mounted on exterior panel adjacent to pressure gauge.

7.1.3.2 400 Hz Components. The 400-Hz components shall be as follows (refer to MIL-HDBK 1004/5):

a) For a 400 Hz central distribution system, provide a three-pole, 600 V, 400 Hz input circuit breaker shall be provided that shall be operable from the front of the apron service point enclosure. For systems where the 400 Hz converter is located at the apron service point, refer to par. 7.1.3.1.

b) 400 Hz output from the apron service point enclosure shall be through either electrically operated contactors or 400 Hz circuit breakers. Typically, contactors are utilized on systems with aircraft having a 48 V dc feedback circuit and shall have three-phase overload protection. Contactors and breakers shall be furnished with lugs for connection of the four-wire, Size 2 AWG conductor, flexible aircraft power cable that conforms to MS90328, Cable Assembly External Electric Power, Aircraft 115/200 Volt, 400 Hertz (Government-furnished equipment). Provide cable grips and neoprene grommets for enclosure sidewall openings for the direct (hard-wired) connection of the aircraft power cable to the contactor.

c) Each contactor and circuit breaker shall have two weatherproof pilot lights, one marked "Power On" with red lens and one marked "Power Off" with green lens mounted on exterior of the enclosure (on the side of the associated contactor or breaker). Operate the contactor and breaker from the front of the enclosure.

Section 8: HANGAR SERVICE POINTS

8.1 Hangar Service Points. The function of the service points is to dispense compressed air, preconditioned air, and electrical services for aircraft maintenance in the hangar space. Service points shall be located near the center of each two aircraft spaces and shall provide service for two aircraft. (Service points shall be installed on hangar fire wall at a minimum of 18 in. (457 mm) above hangar finished floor. Conduits entering this area from below are to have seal fittings. For details of enclosure and equipment installations see Figures 9, 11, 12, 13, and 14. If fire lanes are not provided along fire wall, markings shall be provided on the hangar floor to define a 5 ft (1.5 m) minimum radius about the service points. Aircraft extremities shall not extend into the marked zones. Signs warning of hazardous zones shall be furnished and installed above each service point. Signs shall read: "WARNING - KEEP AIRCRAFT ENGINE AND FUEL TANK AREAS OUTSIDE OF MARKED ZONES." Installation in the high bay area shall be in accordance with the requirements of the NFPA 70.

8.1.1 Construction. Hangar service points shall have wall-mounted, formed-sheet aluminum enclosures for electrical equipment. The enclosure shall have hinged and gasketed access doors. Compressed-air apparatus shall be mounted on sheet steel structural support board attached to a steel channel wall bracket.

8.1.2 Compressed Air Equipment Components. Compressed-air piping and appurtenances shall be wall mounted adjacent to the electrical apparatus at each service point. Each service point shall be provided with a 1 in. (25.4 mm) air supply line from the 2 in. (51 mm) hangar main. Each service point shall contain the following:

- a) Two 1/2 in. (38 mm) needle valve shutoffs,
- b) Two pneumatic tool filters,
- c) Two 90 psig (620.52 kPa) pressure regulators,
- d) Two pneumatic tool lubricators,
- e) Four pneumatic tool quick-connectors, and
- f) Two wall-mounted hose racks (tool air hoses are Government-furnished equipment).

8.1.3 Preconditioned Air Equipment Components. Preconditioned air service drop from secondary coils shall have 75 ft (22.86 m) length of 8 in. (203.2 mm) flexible duct looped over wall-mounted rack. Each service point shall have the following:

- a) One 8 in. motorized shutoff valve,
- b) One service selector switch in NEMA 1 enclosure,
- c) One wall-mounted hose rack, and
- d) One 75 ft (23 m) length of 8 in. insulated flexible duct (aircraft connections are Government-furnished equipment).

8.1.4 Preconditioned Air Equipment Components (Alternate).

Preconditioned air service drop from secondary coils shall extend from secondary coils down fire wall near compressed air apparatus and under the deck in polyvinyl chloride (PVC) conduit to service pit mounted flush with deck (1 in. drainage runoff lip) near center of hangar or aircraft service point. Ductwork installed below deck shall be high-pressure preinsulated flexible duct. The end 10 ft (3.05 m) section shall be spring-loaded, self-storing type to assist replacement in pit after use. Each service point shall have the following:

- a) One 8 in. motorized shutoff valve (at fire wall),
- b) One service selector switch in NEMA 1 enclosure (at fire wall),
- c) One length as required 8 in. high-pressure preinsulated flexible duct,
- d) One 10 ft (3.05 m) length, 8 in. high-pressure preinsulated flexible duct, spring-loaded type,
- e) One length as required 10 in. (254 mm) PVC conduit with long radius sweep-type elbows and 2 in. drainage tap at low point,
- f) One elastomeric boot seal to connect metal duct drop to flexible duct and conduit, and
- g) One fiberglass service pit with cast aluminum removable pit cover and access door for preconditioned air duct. (Aircraft coupler is Government-furnished equipment.)

The PVC conduit for the underground flexible duct shall have provision for drainage which shall be collected in common drain header and routed to plumbing sanitary or storm sewer as required by local code.

8.1.5 Electrical System Components. Service points shall contain 60 Hz and 400 Hz components as follows.

8.1.5.1 60 Hz Components. The 60 Hz components shall consist of:

a) Two 100 ampere, three-pole, 600 V, 60 Hz, molded case circuit breakers mounted on the interior of the enclosure.

b) Two 100 ampere, 480 V, three-phase, four-wire, 60 Hz receptacles conforming to MIL-C-22992 (Class L) and MS90555-C-44-150S (Government-furnished equipment). This receptacle will match cable plugs MS90556C-44-151P, MS90556-C-44-152P, or MS90556-C-44-156P provided with the ground support equipment. Receptacles shall be mounted on the bottom exterior of the enclosure. Provide additional receptacles to match aircraft requirements.

c) One 3 kVA, one-phase, 480-120 V, 60 Hz, dry type transformer with two-pole primary circuit breaker and a one-pole, 20 ampere secondary breaker. The transformer shall provide power for control and 120 V receptacles. The transformer and the protecting breakers shall be mounted on the interior of the electrical enclosure.

d) Two 20 ampere, 125 V, one-phase, two-pole, three-wire, duplex receptacles with ground fault interrupting. One receptacle shall be mounted on each of the exterior center, hinged panels.

8.1.5.2 400 Hz Components. The 400 Hz components shall consist of:

a) 400 Hz output from the hangar service point enclosure shall be through either electrically operated contactors or 400 Hz circuit breakers. Typically, contactors are utilized on systems with aircraft having a 48 V dc feedback circuit and shall have three-phase overload protection. Contactors and breakers shall be furnished with lugs for connection of the four-wire, Size 2 AWG conductor, flexible aircraft power cable that conforms to MS90328 (Government-furnished equipment). Provide cable grips and neoprene grommets for enclosure sidewall openings for the direct (hard-wired) connection of the aircraft power cable to the contactor.

b) Each contactor and circuit breaker shall have two pilot lights, one marked "Power On" with red lens and one marked "Power Off" with green lens mounted on exterior of the enclosure (on the side of the associated contactor or breaker). Operate the contactor and breaker from the front of the enclosure.

APPENDIX A
METRIC EQUIVALENT CHART

The following metric equivalents are approximate and were developed in accordance with ASTM E380, Use of the International System of Units (SI) and ASTM E621, Use of Metric (SI) Units in Building Design and Construction.

<u>English (yd)</u>	<u>Metric (m)</u>
7000	6,401
1700	1,554

<u>English (ft)</u>	<u>Metric (m)</u>
1200	366
500	152
200	61
50	15

<u>English (ft)</u>	<u>Metric (mm)</u>
70	21 325
48	14 625
24	7325
20	6100
12	3660
10	3000
8	2450
6	1850
5	1500
4	1220
3	915
1	305

<u>English (in.)</u>	<u>Metric (mm)</u>
2000	50 800
70	1775
36	1000
30	750
26	660
25	625

APPENDIX A (Continued)

<u>English (sq. ft')</u>	<u>Metric (sq. m')</u>
450	41.8
150	13.95
1	0.093
<u>English (fpm)</u>	<u>Metric (m/s)</u>
75	0.381
60	0.305
50	0.250
<u>English (cfm)</u>	<u>Metric (cu. m/s)</u>
150	0.0708
50	0.0236
40	0.0189
7.5	0.0037
1	0.0005
<u>English (lb)</u>	<u>Metric (kg)</u>
18 000	8165
12 000 (6 T)	5443
10 000 (5 T)	4536
6000 (3 T)	2725
4000 (2 T)	1814
3000	1361
2000 (1 T)	907
500	230
<u>English (lb/hr)</u>	<u>Metric (kg/s)</u>
200	0.0252
<u>English (psf)</u>	<u>Metric (Pa)</u>
300	14 364
100	4788
4000	27 579 200
125	861 850
100	689 480
90	620 532
60	413 688
30	206 844

(Inch of Water at 39.2 degrees F)

APPENDIX A (Continued)

<u>English (psi)</u>	<u>Metric (pa)</u>
0.10	24.91
<u>English (degrees F)</u>	<u>Metric (degrees C)</u>
85	29
75	24
65	18
<u>English (degrees F)</u>	<u>Metric (degrees C)</u>
25	-04
15	-10
-10	-23
<u>English (Footcandles)</u>	<u>Metric (lux)</u>
70	753.5
50	538.2
30	322.9
2	21.5

BIBLIOGRAPHY

- Connector, Plug, Attachable, External Electric Power, Aircraft,
115/200 Volt, 400 Hertz, MIL-STD-25486
- Control of Electromagnetic Interference Emissions and Susceptibility,
MIL-STD-461
- Definitive Designs for Naval Shore Facilities, NAVFAC P-272 (Pt I)
- Fire Protection for Facilities Engineering Design and Construction,
MIL-HDBK-1008B
- Lead Exposure and Design Consideration for Indoor Firing Ranges,
Thomas L. Anania and Joseph A. Seta
- National Institute for Occupational Safety and Health Publication
- Soils and Foundations, NAVFAC DM-7 Series

REFERENCES

NOTE: THE FOLLOWING REFERENCED DOCUMENTS FORM A PART OF THIS HANDBOOK TO THE EXTENT SPECIFIED HEREIN. USERS OF THIS HANDBOOK SHOULD REFER TO THE LATEST REVISIONS OF CITED DOCUMENTS UNLESS OTHERWISE DIRECTED.

MILITARY SPECIFICATIONS, STANDARDS, AND STANDARD DRAWINGS, MILITARY HANDBOOKS, AND NAVFAC GUIDE SPECIFICATIONS, P-PUBLICATIONS, AND DESIGN MANUALS:

Unless otherwise indicated, copies are available from the Naval Publications and Forms Center, Standardization Document Order Desk, 700 Robbins Avenue, Building 4D, Philadelphia, PA 19111-5094.

SPECIFICATIONS

MIL-C-22992 Connectors, Plugs and Receptacles, Electrical, Waterproof, Quick Disconnect, Heavy Duty Type.

STANDARDS

MIL-STD-704 Aircraft Electric Power Characteristics.

STANDARD DRAWINGS

MS90328 Cable Assembly External Electric Power, Aircraft 115/200 Volt, 400 Hertz.

HANDBOOKS

MIL-HDBK-274 Electrical Grounding for Aircraft Safety.

MIL-HDBK-1003/3 Heating, Ventilating, Air Conditioning, and Dehumidifying Systems.

MIL-HDBK-1004/1 Electrical Engineering, Preliminary Design Considerations.

MIL-HDBK-1004/2 Power Distribution Systems.

MIL-HDBK-1004/3 Switchgear and Relaying.

MIL-HDBK-1004/4 Electrical Utilization Systems.

MIL-HDBK-1004/5 400-Hertz Medium-Voltage Conversion/ Distribution and Low-Voltage Utilization Systems.

MIL-HDBK 1028/6A

MIL-HDBK-1004/6 Lightning Protection.

MIL-HDBK-1021/4 Rigid Pavement Design for Airfields.

MIL-HDBK-1028/1 Aircraft Maintenance Facilities.

GUIDE SPECIFICATIONS

NFGS-16302 Underground Transmission and Distribution.

NFGS-16320 Exterior Lighting.

P-PUBLICATIONS

P-80 Facility Planning for Navy and Marine Corps
Shore Installations.

P-355 Seismic Design for Buildings.

DESIGN MANUALS

DM-1 series Architecture.

DM-2 series Structural Engineering.

DM-3 series Mechanical Engineering.

DM-3.05 Compressed Air and Vacuum Systems.

DM-4 series Electrical Engineering.

DM-21 series Airfield Pavement Design.

DM-21.3 Flexible Pavement Design for Airfields.

NON-GOVERNMENT PUBLICATIONS:

AMERICAN NATIONAL STANDARDS INSTITUTE (ANSI)

ANSI C2 National Electrical Safety Code.

ANSI B31.1 Power Piping.

(Unless otherwise indicated, copies are available from the American National Standards Institute (ANSI), 11 West 42nd Street, New York, NY 10036.)

AMERICAN SOCIETY FOR TESTING AND MATERIALS (ASTM)

- | | |
|------------|---|
| ASTM A 53 | Pipe, Steel, Black and Hot-Dipped, Zinc-Coated, Welded, and Seamless. |
| ASTM E 380 | Use of the International System of Units (SI). |
| ASTM E 621 | Use of Metric (SI) Units in Building Design and Construction. |

(Unless otherwise indicated, copies are available from the American Society for Testing and Materials (ASTM), 1916 Race Street, Philadelphia, PA 19103-1187.)

AMERICAN SOCIETY OF MECHANICAL ENGINEERS (ASME)

ASME Boiler and Pressure Vessel Code, Section VIII, Unfired Pressure Vessels.

(Unless otherwise indicated, copies are available from the American Society of Mechanical Engineers (ASME), 345 East 47th Street, New York, NY 10017.)

BUILDING OFFICIALS AND CODE ADMINISTRATORS INTERNATIONAL ASSOCIATION (BOCA)

BOCA International Plumbing Code.

(Unless otherwise indicated, copies are available from Building Officials and Code Administrators International Association (BOCA), 4051 West Flossmor Road, Country Club Hills, IL 60478-5795.)

NATIONAL FIRE PROTECTION ASSOCIATION (NFPA)

NFPA 70 National Electrical Code.

(Unless otherwise indicated, copies are available from National Fire Protection Association (NFPA), One Batterymarch Park, P.O. Box 9101, Quincy, MA 02269-9101.)

GLOSSARY

ECS. Environmental control system.

FPUS. Fixed point utility systems.

GSE. Ground support equipment.

NAVAIR. Naval Air Systems Command.

NAVFACENCOM. Naval Facilities Engineering Command.

NEMA. National Electrical Manufacturers Association.

PVC. Polyvinyl chloride.

CUSTODIAN
NAVY YD2

PREPARING ACTIVITY
NAVY YD2

PROJECT NO.
FACR-1147

STANDARDIZATION DOCUMENT IMPROVEMENT PROPOSAL

INSTRUCTIONS

1. The preparing activity must complete blocks 1, 2, 3, and 8. In block 1, both the document number and revision letter should be given.
2. The submitter of this form must complete blocks 4, 5, 6, and 7.
3. The preparing activity must provide a reply within 30 days from receipt of the form.

NOTE: This form may not be used to request copies of documents, nor to request waivers, or clarification of requirements on current contracts. Comments submitted on this form do not constitute or imply authorization to waive any portion of the referenced document(s) or to amend contractual requirements.

I RECOMMEND A CHANGE:	1. DOCUMENT NUMBER MIL-HDBK-1028/6	2. DOCUMENT DATE (YYMMDD) 960531
------------------------------	---------------------------------------	-------------------------------------

3. DOCUMENT TITLE	AIRCRAFT FIXED POINT UTILITY SYSTEMS
-------------------	--------------------------------------

4. NATURE OF CHANGE (Identify paragraph number and include proposed rewrite, if possible. Attach extra sheets as needed.)	
---	--

5. REASON FOR RECOMMENDATION	
------------------------------	--

6. SUBMITTER		
a. NAME (Last, First, Middle Initial)	b. ORGANIZATION	
c. ADDRESS (Include Zip Code)	d. TELEPHONE (Include Area Code)	7. DATE SUBMITTED:
	(1) Commercial (2) DSN (If applicable)	(YYMMDD)

8. PREPARING ACTIVITY		
a. NAME Commanding Officer, Southern Division Naval Facilities Engineering Command, Code 0741 P. O. Box 190010 North Charleston, SC 29419-9010	b. TELEPHONE (Include Area Code)	
	(1) Commercial (803) 820-7404	(2) DSN 563-7404

	IF YOU DO NOT RECEIVE A REPLY WITHIN 45 DAYS, CONTACT: Defense Quality and Standardization Office 5203 Leesburg Pike, Suite 1403, Falls Church, VA 22041-3466 Telephone (703) 756-2340 DSN 289-2340	
--	---	--